



# LifeSize<sup>®</sup> Video Communications Systems User and Administrator Guide

---

February 2011

LifeSize Room 220  
LifeSize Team 220  
LifeSize Express 220

# LifeSize Video Communications Systems

This guide explains how to use and configure LifeSize 220 series systems. For information about LifeSize Passport, refer to the *LifeSize Passport User and Administrator Guide*. For information about how to install LifeSize video communications systems, refer to the *LifeSize Video Communications Systems Installation Guide*. Related documentation is available from the documentation CD included with the product and from [lifesize.com/support](https://lifesize.com/support).

This guide is divided into four sections. Use the following table to navigate the content.

<b>Using</b>	Describes how to place and manage calls; start a presentation; and create a recording. Read more at <a href="#">Using LifeSize Video Communications Systems</a> .
<b>Configuring</b>	Describes how to administer the system. Administrator functionality is password protected. Read more at <a href="#">Configuring LifeSize Video Communications Systems</a> .
<b>Preferences</b>	Lists configuration preferences and their default values. Read more at <a href="#">Preferences</a> .
<b>Troubleshooting</b>	Describes symptoms, possible causes, and potential solutions to issues you may encounter with your system. Read more at <a href="#">Troubleshooting</a> .

Extend the capabilities of your LifeSize system by integrating LifeSize infrastructure products. Your environment may include one or more of these LifeSize products:

<b>LifeSize Bridge</b>	Enables multiway video conferencing. LifeSize video systems with multiway calling are limited to a maximum of 8 participants in a call. Using LifeSize Bridge to host the call expands the capability to additional participants.
<b>LifeSize Video Center</b>	Allows video streaming, recording, and publishing when integrated with your LifeSize video system. Viewers access these videos and live streams from the LifeSize Video Center server through a browser-based interface on their computers. Read more at <a href="#">Creating a Recording</a> .
<b>LifeSize Control</b>	Enables multi-vendor IP management of video communications systems and infrastructure devices. Administrators use LifeSize Control to maintain licenses, schedule calls, and generate reports in a secure environment.
<b>LifeSize Transit</b>	Firewall and NAT traversal solution that enables video calls within and across enterprises and organizations. With LifeSize Transit configured in your environment, you can place secure video calls with your system from outside the firewall.
<b>LifeSize Desktop</b>	Standalone client that provides two-way video calling to other LifeSize systems and other standards-based video devices. LifeSize Desktop allows mobile workers to stay connected.
<b>LifeSize Networker</b>	Provides an all-in-one, enhanced gateway for integration between IP and ISDN networks. LifeSize Networker offers multiple compact network interfaces that allow users to connect LifeSize video systems with ISDN video systems.







Learn more about these products at [lifesize.com/support](https://lifesize.com/support).

# Section 1: Using LifeSize Video Communications Systems

## Getting Started

When your LifeSize system is idle, a screen saver appears or the screen is black. An incoming call or pressing any button on the remote control automatically activates the system. Point the remote control at the IR receiver (typically located on the camera or the codec), not the screen, to activate the system.

The navigation bar at the bottom of your LifeSize system's main screen contains icons that correspond to buttons on the remote control. As you use the arrow keys on the remote control to navigate to different parts of the screen, the icons change depending on available actions. Use the remote control to perform the following tasks:



<b>Placing, answering, and ending a call</b>	From the main screen, select <b>Video Call</b> (or <b>Voice Call</b> ) and press <b>OK</b> . Enter the number and press  to place a call. Press <b>OK</b> to answer a call and  to end a call. Read more at <a href="#">Placing a Call</a> , <a href="#">Automatically Answering Calls</a> , and <a href="#">Managing a Call</a> .
<b>Initiating a presentation</b>	By default, support for presentations is enabled on your LifeSize system. If you connect a laptop to a video input on the system during a call, a presentation starts automatically. If a presentation does not start automatically, press  . Read more at <a href="#">Initiating a Presentation</a> .
<b>Controlling a near or far end camera</b>	To adjust the near end camera when the system is idle, press the <b>near/far</b>  camera button. During a call, press  to switch between the near and far end cameras. Read more at <a href="#">Controlling a Far End Camera</a> .
<b>Selecting a screen layout</b>	Press  to change the screen layout during a call. Read more at <a href="#">Managing Video Layouts</a> .
<b>Creating a recording</b>	With LifeSize Video Center configured, you may create a recording in and out of a call. Read more at <a href="#">Creating a Recording</a> .

## Placing a Call

Place a video or voice call with your LifeSize system as follows:

- [Dialing a Number with the LifeSize Phone](#) or [Dialing a Number from the Main Screen](#). When placing a video call using the remote control or the **video** button on the LifeSize phone, dial phone numbers or IP addresses.
- [Placing a Call from the REDIAL List](#) on the main screen or [Placing a Call from the Directory](#).

Using a comma in a number specifies a one-second pause in the dialing sequence. This may be required when you place a PSTN call that requires a pause after dialing the first number to obtain an outside line. To increase the duration of the pause, use more than one comma.



A video icon  represents a video call in progress. Each orange circle on the right represents a video call participant. A voice icon  shows the number of voice call participants.

By default, the system information, status bar, and navigation bar are hidden after a call has been connected for 10 seconds. These items reappear after interaction with the system. Adjust the fade out interval in **User Preferences : Appearance : Fade Out Timeout**. To hide or show user interface elements during a call, press .



## Dialing a Number with the LifeSize Phone

When the LifeSize phone is connected to your video system, use the keys on the phone keypad to dial a voice or video call. To place a call, press the **voice** or **video** key and enter the number using the numeric keys.

## Dialing a Number from the Main Screen

1. Use the arrow keys on the remote control to select **Video Call** (or **Voice Call**) and press **OK**.
2. Enter the number you wish to call. The last number entered appears by default. Press  to delete the number.
3. Press **call** .



Additional options:

<b>Edit options</b>	<p>Before placing the call, you may edit the number as follows:</p> <ul style="list-style-type: none"> <li>• Press  to delete a character.</li> <li>• Press  to change the text entry method. By default, text entry is numeric and <b>123</b> appears at the bottom of the screen. To enter a hostname, such as <i>meetingroom.company.com</i>, select the <b>abc</b> option. Use the <b>0x1a</b> option to enter an IPv6 address when your LifeSize system is connected to an IPv6 network. If IPv6 addressing is enabled, the IPv6 address appears on page 1 of <b>System Information</b>.</li> <li>• Press  to display the keyboard from which you can enter alphanumeric characters. Use the arrow keys to navigate to the character you wish to enter and press <b>OK</b>.</li> </ul> <p><i>Video Calls Only:</i> Press <b>OK</b> to exit the field.</p>
<b>Maximum video bandwidth</b>	<p>Set the maximum bandwidth for video calls by navigating to the list next to the entry box for numbers and pressing <b>OK</b>. Use the arrow keys to select a maximum bandwidth for the call and then press <b>OK</b>.</p>

## Placing a Call from the REDIAL List

To place a call from the **REDIAL** list on the main screen, use the arrow keys on the remote control to select an entry and press **OK**.

The **REDIAL** list stores up to 15 recently dialed numbers. The last call placed always appears at the top of the list. Unless it is locked, the oldest entry in the list is automatically removed when the system receives a call after the maximum number of entries has been reached.

Each entry includes the name of the party called and an icon that indicates whether the number is a voice  or video  number. If the system receives a call but does not answer it, the call appears in the **REDIAL** list as a missed call. The  symbol appears next to the name in the entry.

Adjust the maximum number of entries in the **REDIAL** list in **User Preferences : Calls : Maximum Redial Entries**. You can also remove or lock entries; and add entries from the **REDIAL** list to the local directory. Read more at [Managing the REDIAL List](#).

## Including Multiple Sites in Calls

If your system is hosting a conference call and all callers are connecting to your system, add participants to an existing call at any time.

1. Press  to return to the main screen to add a new caller.
2. Do one of the following:
  - Select a number from the **REDIAL** list and press **OK**. An orange LED indicator appears in the **REDIAL** list to the left of the voice or video numbers currently in a call.
  - Select a number from the directory. Refer to [Placing a Call from the Directory](#).
  - Dial a number using the **Voice Call** or **Video Call** selections. Refer to [Dialing a Number from the Main Screen](#).
  - Press the **add** key on the phone keypad and enter the new number. Next, press the **voice** key or the **video** key on the phone keypad, depending on the type of call you are placing.

---

**NOTE** If a call connects using PSTN connectivity, you must use the remote control to add calls.

---

## Initiating a Presentation

LifeSize systems include support for sharing data from the presentation input, which is typically a personal computer connected to the codec, while simultaneously showing video from the primary input.

By default, support for presentations is enabled. During a call, a presentation starts automatically if you connect a video input device other than a camera (for example, a laptop) to a video input on the codec. The presentation stops automatically if the video input device is disconnected from the system.

If support for presentations is enabled but a presentation does not start automatically, follow these steps to start or stop a presentation manually:



1. Press  to start the presentation. The far end can also start a presentation, which stops the current presentation at the near end.

---

**NOTE** If you are using LifeSize Express 220 connected to two displays, the receiving presentation and sending presentation indicators appear in display 1.

---

2. Press  to stop the presentation.

You can show presentation video even if presentations are disabled on your system or another system in a call. If **Start presentation** does not appear, press  to swap the primary and presentation inputs. Pressing  again or ending the call returns the inputs to their original selections.

---

**NOTE** You can change the primary and secondary inputs before the call or at any time during a call. Refer to [Changing Video Inputs](#).

---

## Automatically Answering Calls

Configure your system to automatically answer incoming calls in **User Preferences : Calls**.

Call Preference	Description	Default Value
<b>Auto Answer</b>	If set to <i>Disabled</i> , you must manually answer or ignore incoming calls. When <b>Auto Answer</b> is enabled, the system answers a PSTN call only if another call is already connected.	Disabled
<b>Auto Answer Mute</b>	If set to <i>Enabled</i> and <b>Auto Answer</b> is set to <i>Enabled</i> , the system is muted when a call connects.	Enabled
<b>Auto Answer Multiway Call</b>	If set to <i>Enabled</i> , the system automatically answers incoming calls after the first call has connected. The system beeps to indicate when a new call connects. The <b>New Call Automatically Answered</b> dialog box appears when video is not available from the incoming call because of the following conditions: <ul style="list-style-type: none"> <li>The second or subsequent incoming call is a voice call. The name and number of the added voice caller appears.</li> <li>The system supports more than four video participants and a fifth or subsequent video participant joins the call. LifeSize systems that support multiway calls can show video images from a maximum of four video participants.</li> <li>The system supports and is configured to show video only from the participant currently speaking or from the last speaker if your site is the current speaker.</li> </ul> Select <b>Hang Up</b> and press <b>OK</b> to hang up the call. If you ignore the dialog box, the system accepts the call.	Enabled

## Enabling Do Not Disturb During Calls

Enable the do not disturb feature from any call screen during a call as follows:

1. Press **OK** on the remote control to display the **Call Manager**.
2. Use the arrow keys to navigate to **Do Not Disturb**.
3. Press **OK**.

If you receive an incoming call during a call and **Auto Answer Multiway Call** is set to *Disabled*, you can choose **Do Not Disturb**, which ignores the incoming call and prevents other calls from interrupting for the duration of the call. The caller hears a busy signal. Calls missed while the do not disturb feature is enabled appear in the **REDIAL** list on the main screen.

## Using System Do Not Disturb

Enable the system do not disturb feature to show only the background image of the main screen with the status and navigation bars and a system do not disturb message. The system responds only to the volume control buttons and the **OK** button on the remote control. Callers hear a busy signal and missed calls appear in the **REDIAL** list. Consider using this feature if you are using the meeting room for a purpose other than a video conference and do not wish to be disturbed by incoming calls.

To enable this feature, follow these steps:

1. From the main screen, press  to access the system menu.
2. Use the down arrow key to select **Do Not Disturb**.
3. Click **OK**.

A dialog box indicates that the system do not disturb feature is enabled.

4. Press **OK** to return the system to normal operation.

## Managing a Call

During a call, you can view call status, manage audio output and video images, control cameras, select input to appear in a display, and initiate a presentation.

To view call statistics during a call, press . Statistics include audio and video transmit and receive data such as bandwidth and packet loss, and commonly indicate the cause of problems you may experience during a call. Statistics automatically refresh every 5 seconds and disappear from view after 5 minutes.

---

**NOTE** With LifeSize Video Center enabled, pressing  starts a recording. Access call statistics instead through the Call Manager: press **OK** and select **Statistics**.

---

## Virtual Multiway

Virtual multiway is system behavior that allows you to do the following if your system is a participant in a multiway call hosted by another LifeSize system:

- Access the same screen layouts that are available to the host. Read more at [Managing Video Layouts](#).
- Control the cameras of all visible participants. Read more at [Controlling a Far End Camera](#).
- View caller information for each participant in the call in the **Call Statistics** screen and the **Call Manager** dialog box.





---

**NOTE** Your administrator may have set up a configuration that does not support virtual multiway. Read more at [Multiway Call Layout of Video Images](#).

---

## Call Encryption

If a video or voice call is encrypted, one of the following icons appears next to the caller ID:

	<p>Denotes a voice call that is encrypted. In the Call Status, Call Manager list, and Call Statistics list, the following icon appears: </p>
	<p>Denotes a video call that is encrypted. In the Call Status, Call Manager list, and Call Statistics list, the following icon appears: </p>

*Video Calls Only:* If your LifeSize system is participating in a multiway call that another LifeSize system is hosting and your connection to the host is encrypted, your display shows the encryption status of the participant's connection to the host. If your connection to the host is not encrypted, all connections appear as unencrypted.

## Adjusting Audio Preferences



Adjust volume preferences for audio inputs at **User Preferences : Audio**. Preferences appear with an audio meter next to the slider. The audio meter expands below the slider when you select the slider and press **OK** on the remote control.

Use the audio meter to determine the best volume setting. If you adjust the volume of the active microphone, position yourself the same distance from the microphone as participants would be in the room during a video conference. Speak and observe the color of the bars that appear in the audio meter. Green bars indicate an acceptable setting at normal speaking volume. Yellow bars are acceptable if you are shouting or speaking loudly. Avoid settings that produce red bars in the audio meter.



For **Active Microphone Volume**, LifeSize recommends a volume setting of 5 to 8 for most LifeSize MicPod configurations and 5 to 10 for most LifeSize Focus configurations.

If you are using the LifeSize phone as the active microphone, **Active Microphone Volume** is not available. The LifeSize phone microphones adjust volume automatically.

## Muting Audio Inputs

An administrator can configure the system to mute only the microphone when you press . Devices connected to the system such as a personal computer or a DVD player continue to send audio during a presentation while the microphone is muted. The **Audio Mute** field on the **System Information** page indicates which devices, either all audio inputs or only the active microphone, are muted when you press . To access **System Information**, press .





## Controlling a Far End Camera

During a video call, a camera icon appears in the video image of the participant whose camera you are controlling. An orange camera icon  indicates control of the primary (near) input. A blue camera icon  in a far end video image indicates control of the far end camera. By default, the near camera is selected.



## Selecting a Far End Camera





Do the following from any call screen:

1. Press the **near/far**  camera button.  
The blue camera icon  appears in the first far end video image in the call.
2. If more than one video participant is connected, continue to press  until  appears in the far end video image of the participant whose camera you wish to control.
3. Use the arrow and zoom keys on the remote control to adjust the PTZ camera.

## Selecting the Far End Primary Input

1. Select the far end participant whose input device you wish to control by following the steps in [Selecting a Far End Camera](#).
2. Press **input**  to choose the far end input device.  
A menu of available input devices appears.
3. Use the arrow keys on the remote control to select a device and press **OK**.

## Ending a Call

Remote control	Press <b>hang up</b>  . Pressing  in a two-way call, ends the call. When you press  in a multiway call, the Call Manager appears.
Call Manager	Press <b>OK</b> to show the Call Manager and select <b>Hang Up</b> .
REDIAL list	Press  to show the main screen and REDIAL list. Select the call you wish to end and press <b>OK</b> .
LifeSize phone	Press the <b>video</b> or <b>voice</b> key.

---

**NOTE** If your LifeSize system is participating in a multiway video call hosted by another LifeSize system, all visible callers appear in the Call Manager rather than only the system hosting the call. You can hang up only your connection to the system hosting the call.

---

## Managing Video Layouts

To change the screen layout of near and far end video images, press  at any time during a call.

The number of the selected screen layout ( $x$ ) and the total number of available screen layouts ( $y$ ) appear in the center of the screen above the status bar as  $x/y$ . The total number of available screen layouts depends on the number of connected callers, whether a single display or a dual display is used, and whether a presentation is being viewed.

Screen layouts appear as one of the following types:

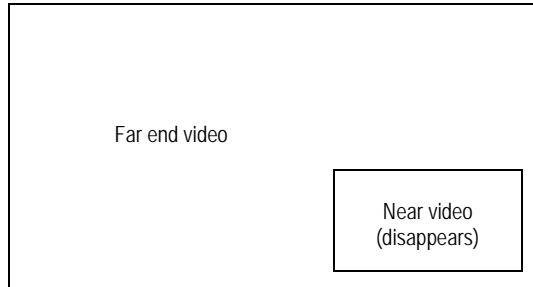

A far end participant or your site (the near end) appears as the largest video image. The example illustrates a two-way call on a single display. The far end is the largest video image.

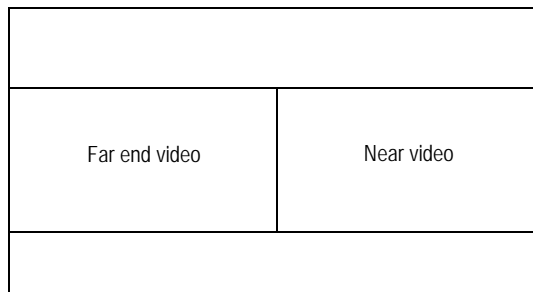

All video images from all participants are the same size.

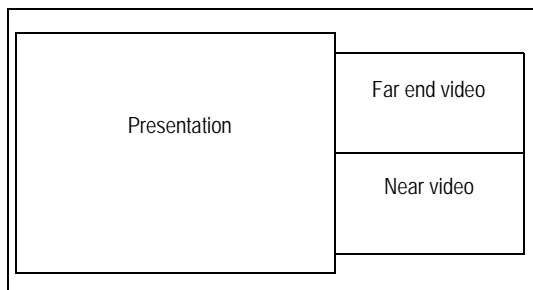

A presentation appears as the largest video image when a presentation is in progress.

---

**NOTE** For a visual depiction of additional available layouts, refer to [Single Display Screen Layouts](#) and [Dual Display Screen Layouts](#).

---

## Multiway Call Layouts

LifeSize video conferencing systems that support multiway video calls can show video from a maximum of four callers: three far end participants and the near end participant. If LifeSize Bridge is hosting the call, video from additional callers may appear.

During a multiway video call, choose a screen layout that shows video from a far end participant as the largest image in the layout in one of the following ways:

- The far end participant who is currently speaking always appears as the largest image. When you choose this layout, the dominant speaker icon  appears to the right of the screen layout number.
- The same far end participant always appears as the largest image regardless of who is currently speaking.

On LifeSize systems that support more than four video participants, video from one of the far end participants not shown on screen in a 5-way or greater call may replace the largest video image in these layouts when that participant becomes the current speaker.

Near end video does not change location when a participant at the near end is the current speaker. If you choose a screen layout that shows all video images the same size, only the dominant speaker icon  moves to indicate which participant is currently speaking.

If your LifeSize system supports more than four video participants in a call, by default the video image from a fifth or greater far end participant appears in the display only when that participant becomes the current speaker and replaces the video image of the earliest of the last three far end speakers.

### Last Speaker Layout Option

If an administrator configured the system to show video only from the last speaker in the call, only the video image from the participant who is currently speaking appears. If a participant at your site is currently speaking, video from the last speaker appears in your display.

### Layout Control in Multiway Calls

If your LifeSize system is a participant in a multiway call with another LifeSize system that is hosting the call, you can manage the layout of video from all participants in the call. In this case, the same number and type of screen layouts that are available to the LifeSize system hosting the call are available to you for selection.

## Single Display Screen Layouts

### Two-way Call

Layouts 1/3 and 2/3

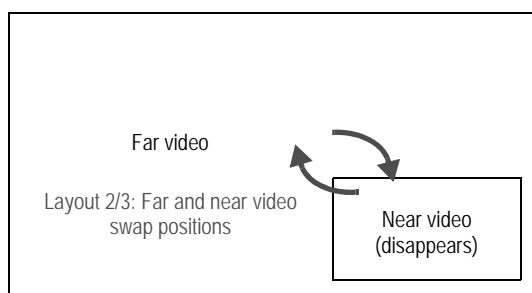

Layout 3/3

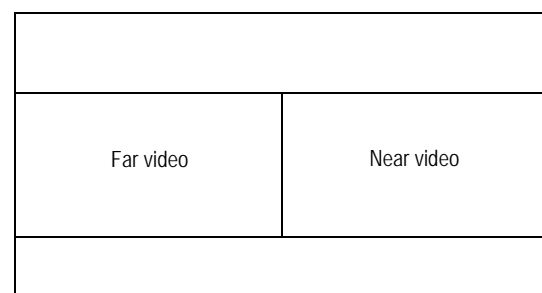

## Two-way Call with Presentation

Layout 1/7

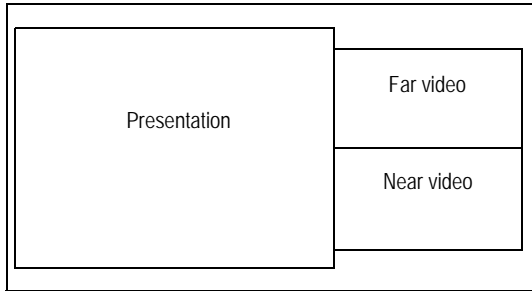

Layout 2/7

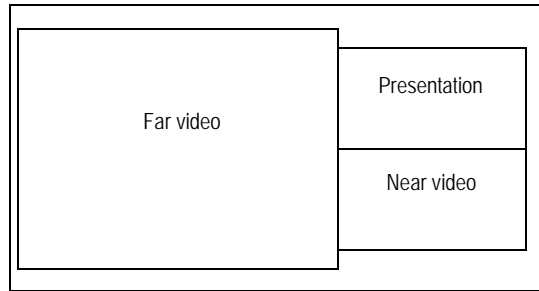

Layout 3/7

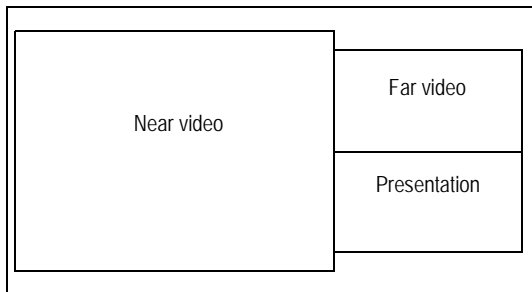

Layout 4/7

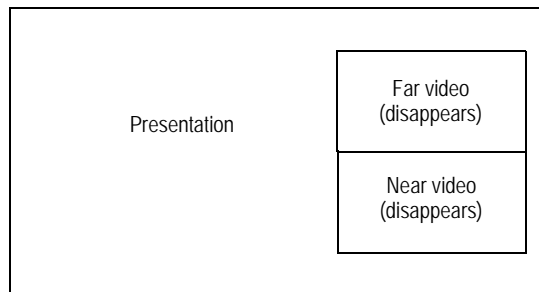

Layout 5/7

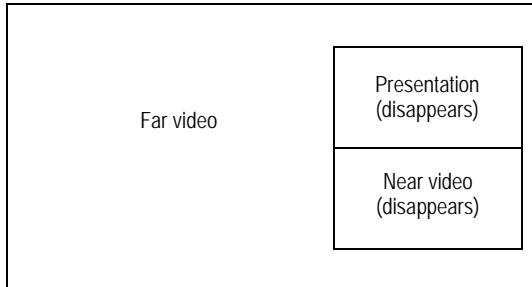

Layout 6/7

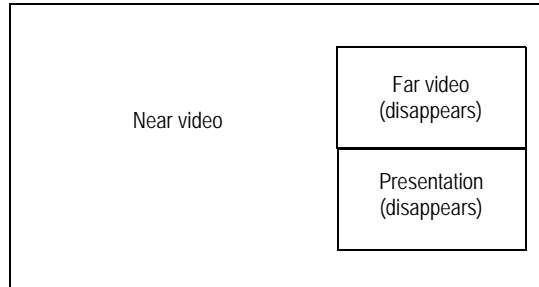

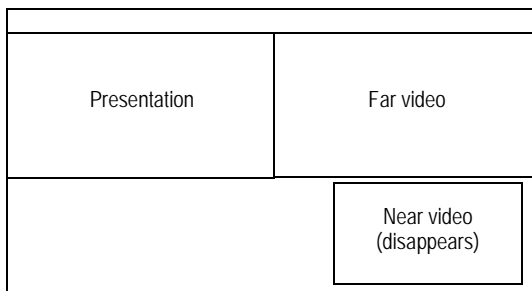

Layout 7/7

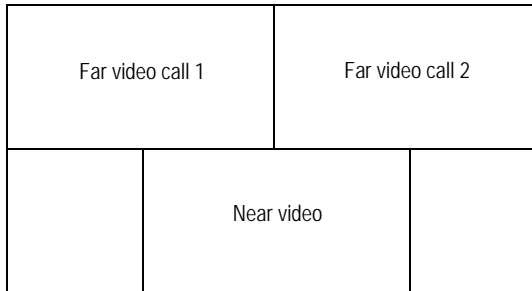

## Three-way Call

Layout 1/7



Layout 2/7 

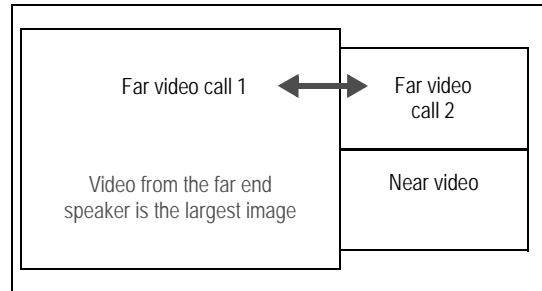

Layout 3/7

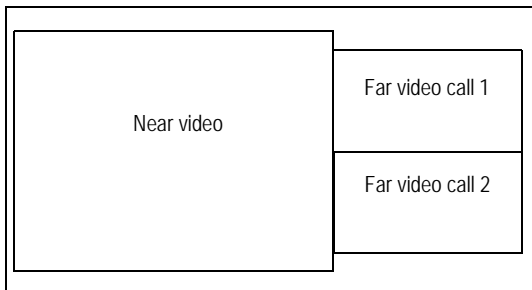

Layout 4/7 

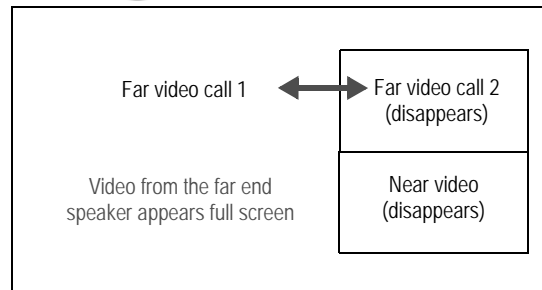

Layout 5/7

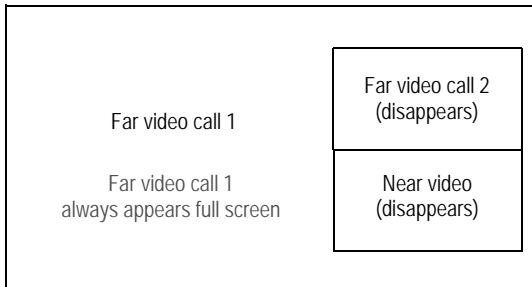

Layout 6/7

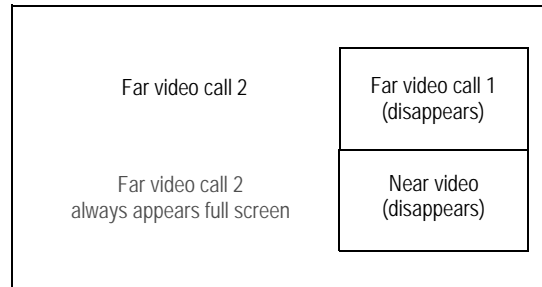

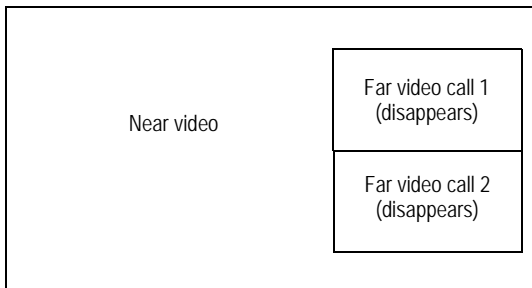

Layout 7/7

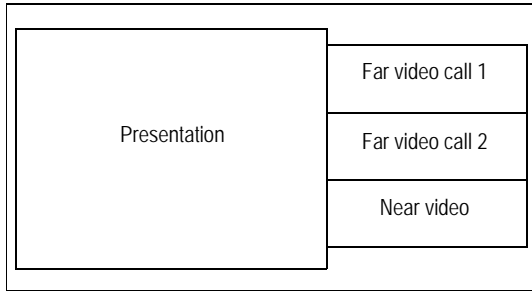

### Three-way Call with Presentation

Layout 1/9



Layout 2/9 

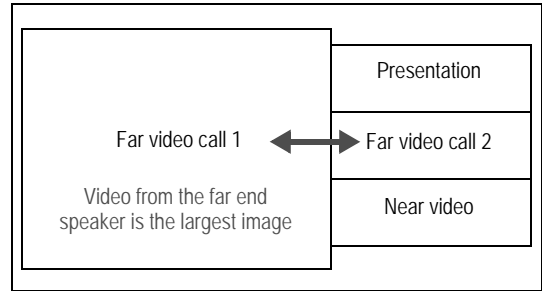

Layout 3/9

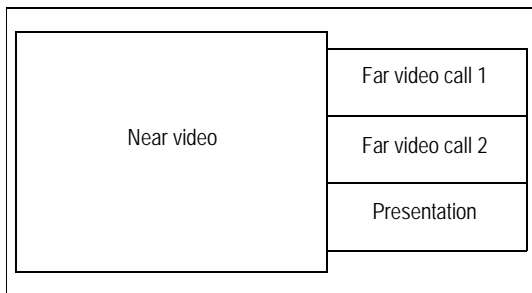

Layout 4/9

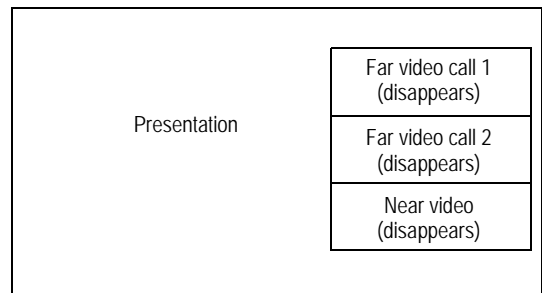

Layout 5/9 

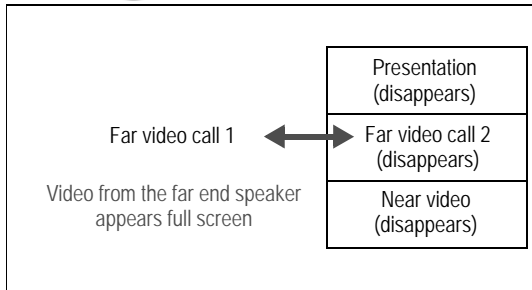

Layout 6/9

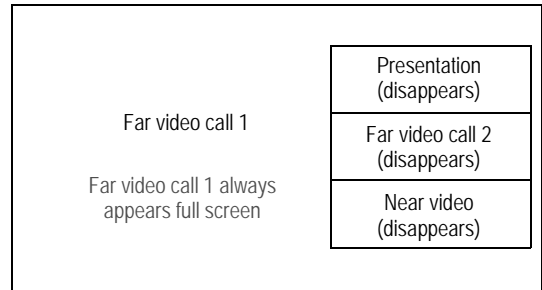

Layout 7/9

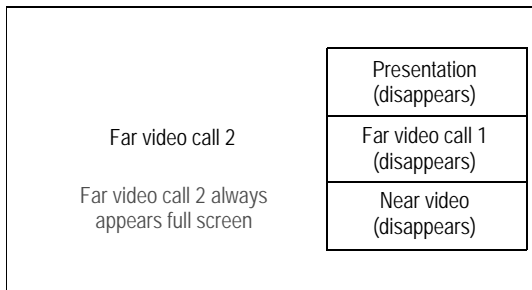

Layout 8/9

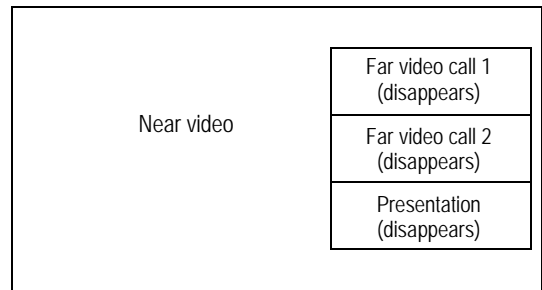

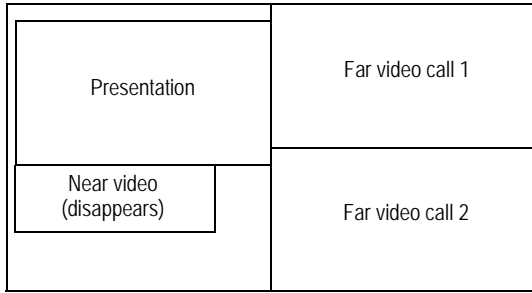

Layout 9/9

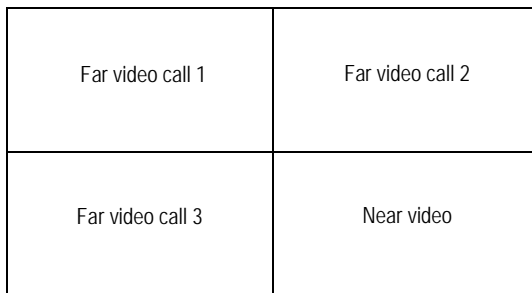

### Four-way Call

Layout 1/8



Layout 2/8 

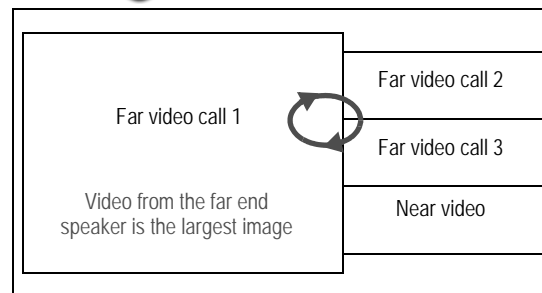

Layout 3/8

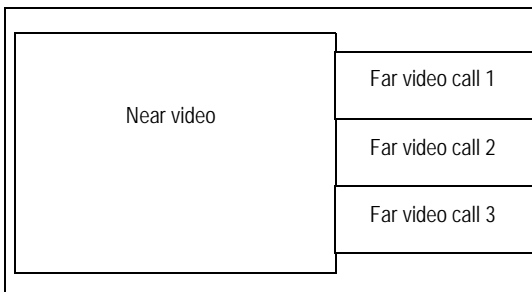

Layout 4/8 

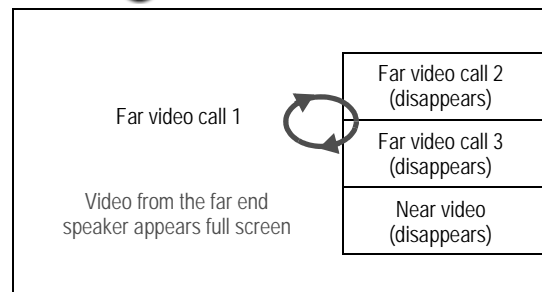

Layout 5/8

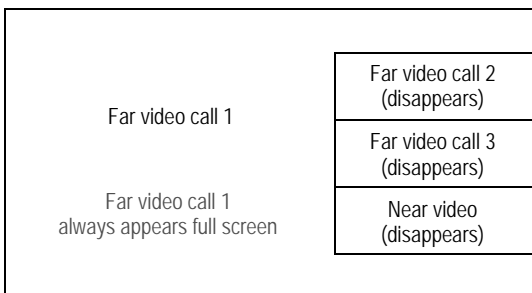

Layout 6/8

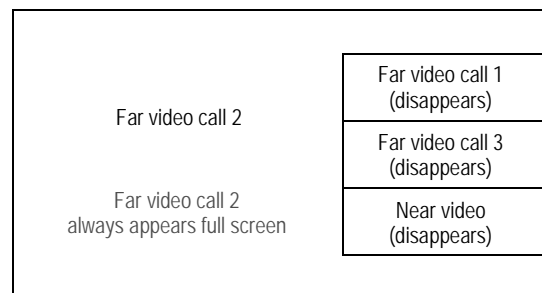

Layout 7/8

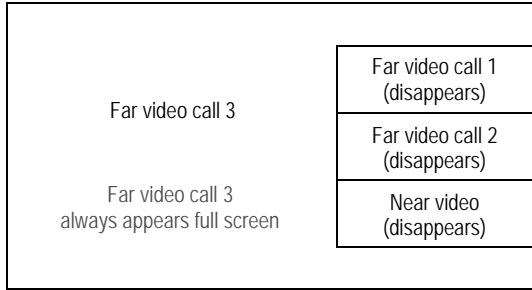

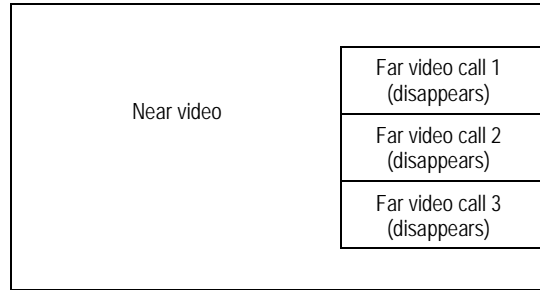

Layout 8/8

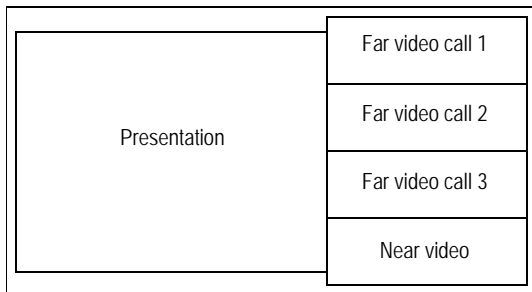

### Four-way Call with Presentation

Layout 1/10



Layout 2/10 

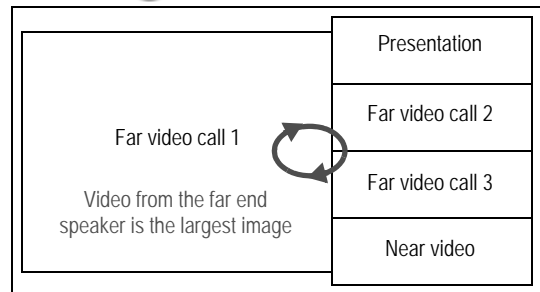

Layout 3/10

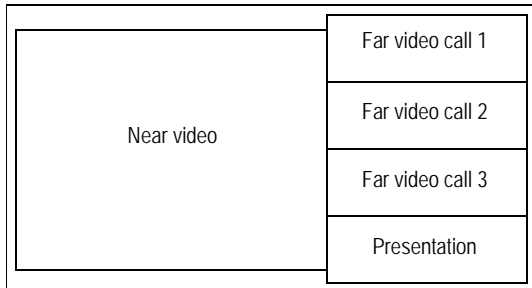

Layout 4/10

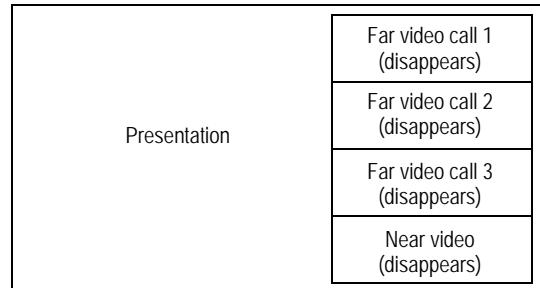

Layout 5/10 

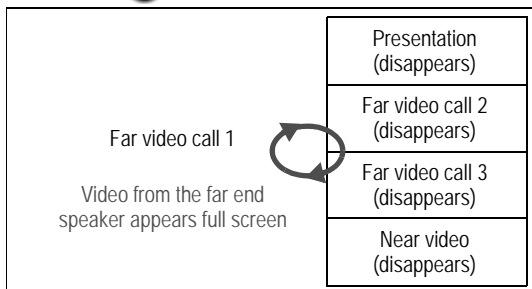

Layout 6/10

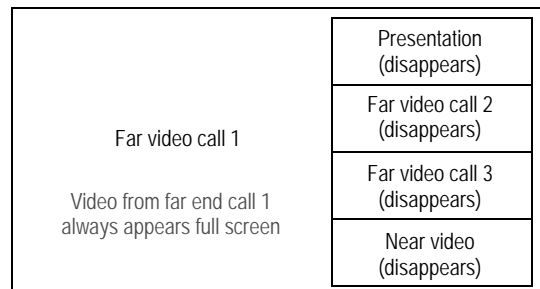



Layout 7/10

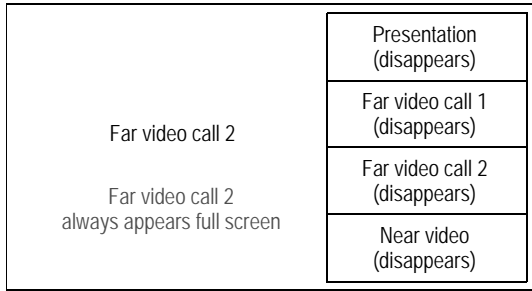

Layout 8/10

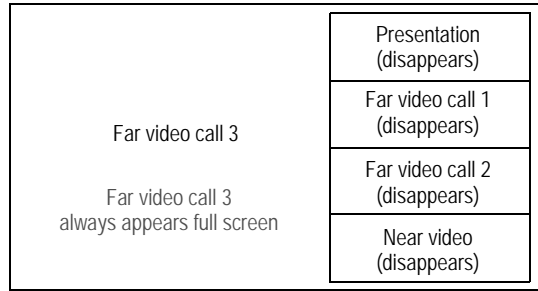

Layout 9/10

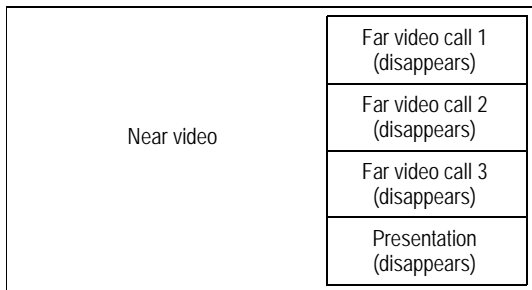

Layout 10/10

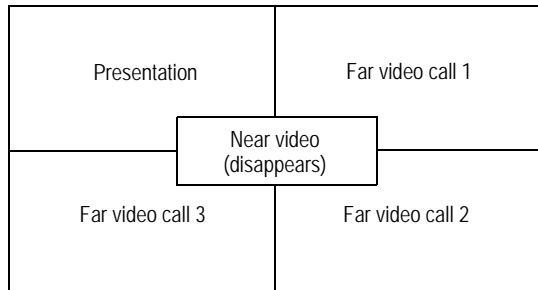

## Dual Display Screen Layouts

To use the following dual display layouts, set **Administrator Preferences : Appearance : Layout : Display 2 Layout** to *Presentations + DVI-I Input* or *Calls + Presentations + DVI-I Input*. For details relating to VGA on Display 2 or using two displays with LifeSize Express 220, refer to the installation guide.

### Two-way Call

Layouts 1/2 and 2/2

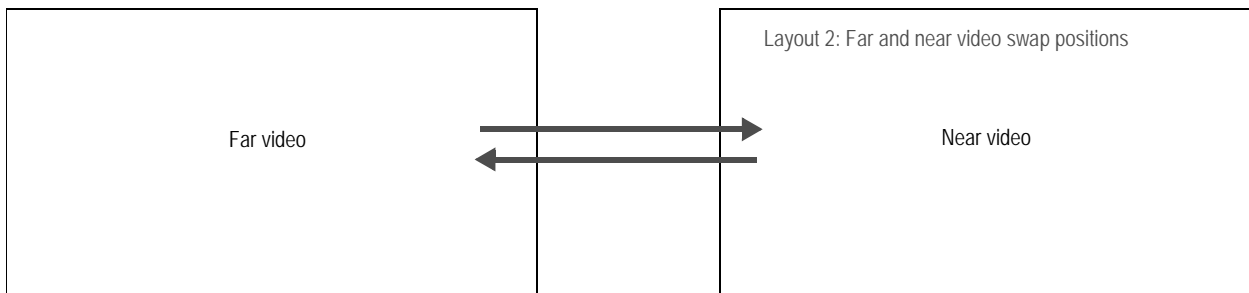

## Two-way Call with Presentation

### Layouts 1/3 and 2/3

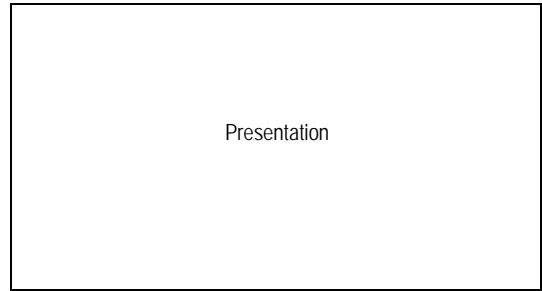
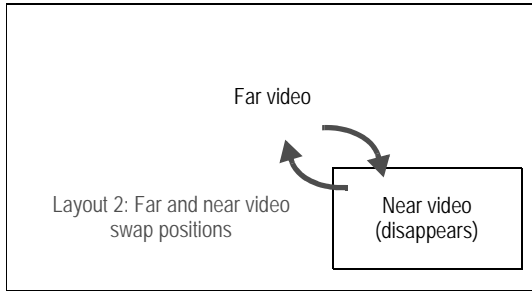

### Layout 3/3

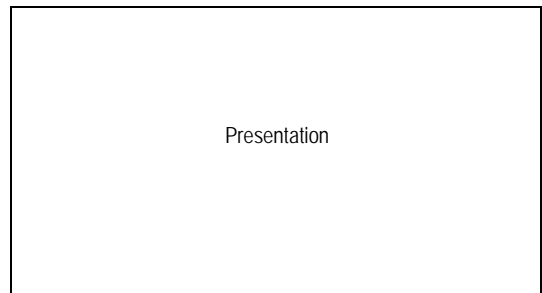
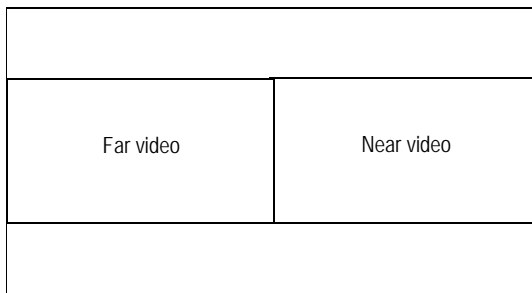

## Three-way Call

### Layout 1/3

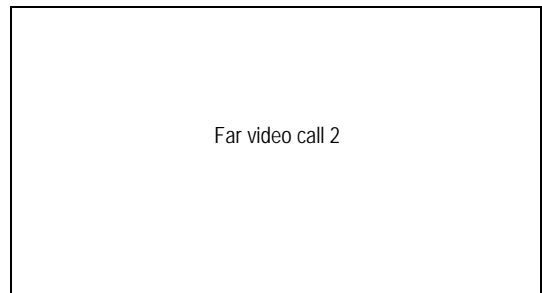
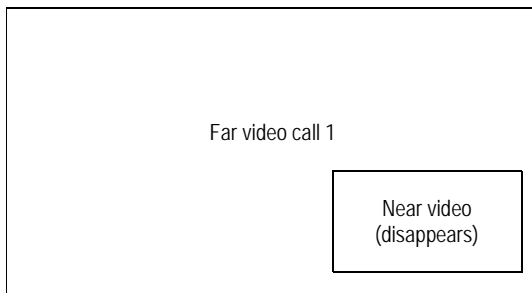

### Layout 2/3

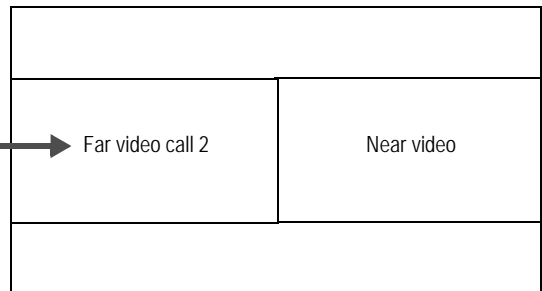
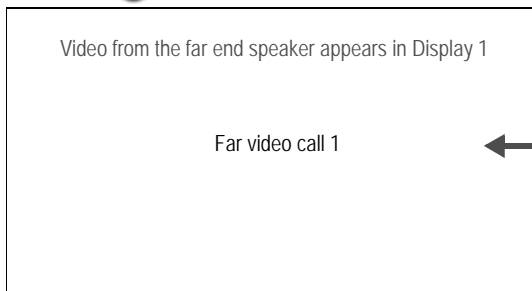

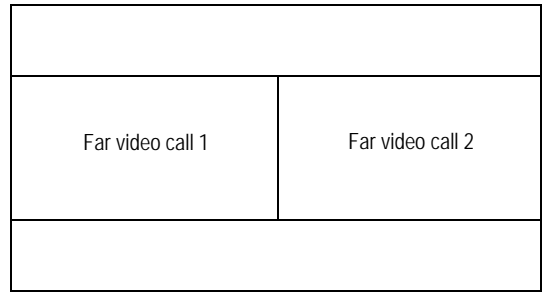
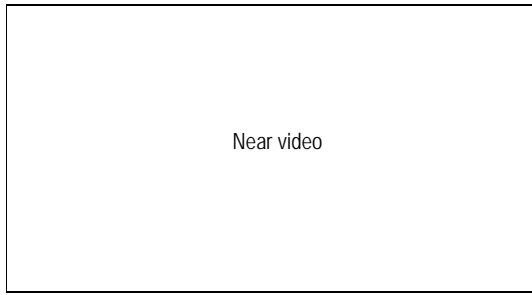

Layout 3/3

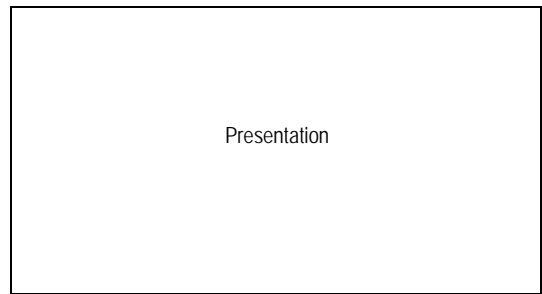
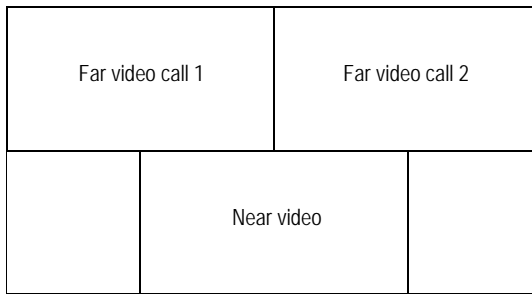

### Three-way Call with Presentation

Layout 1/7



Layout 2/7 

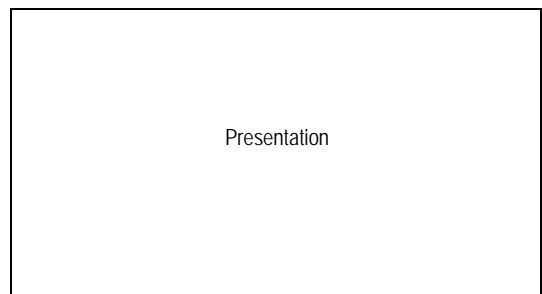
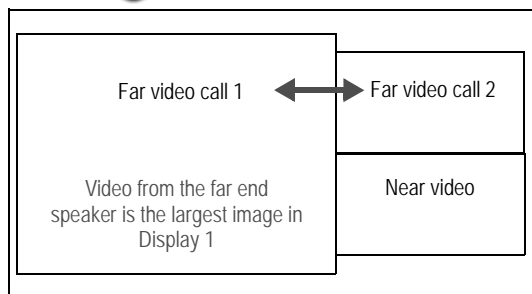

Layout 3/7

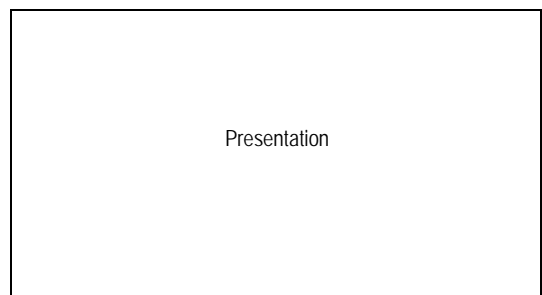
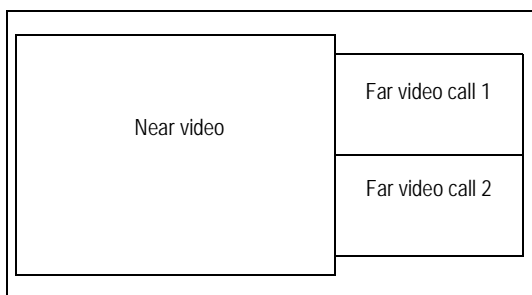

Layout 4/7 

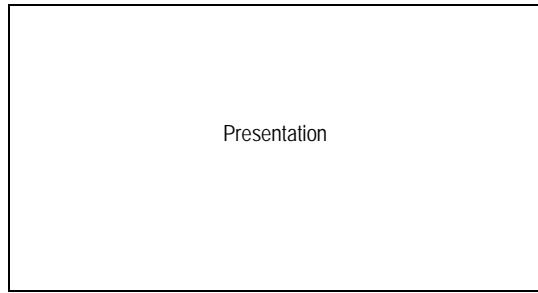
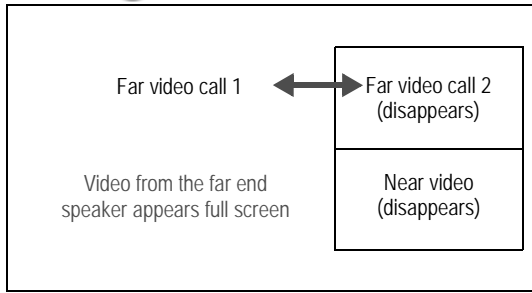

Layout 5/7

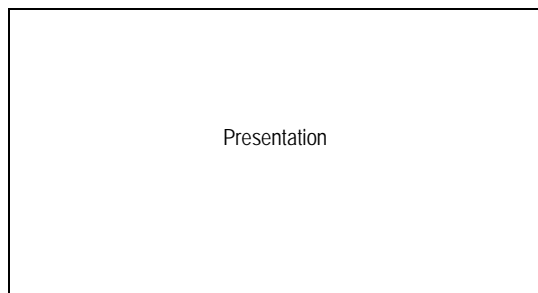
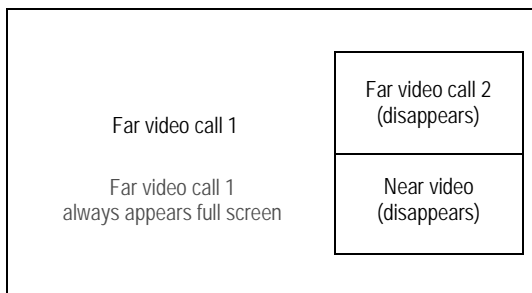

Layout 6/7

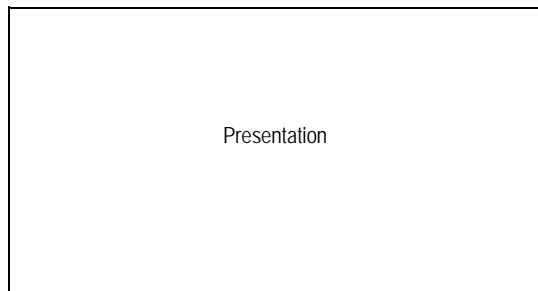
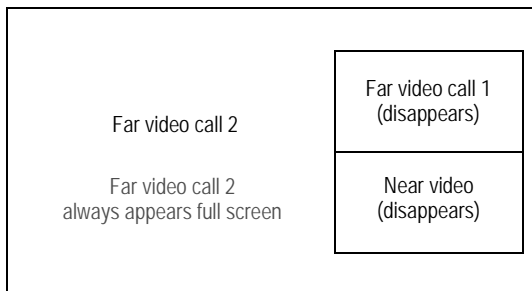

Layout 7/7

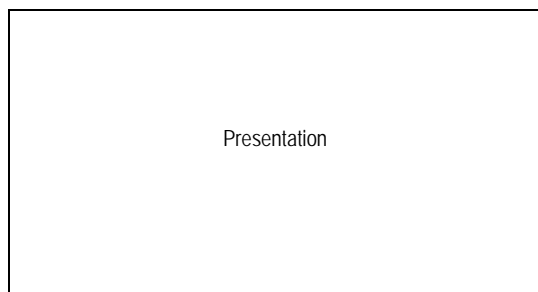
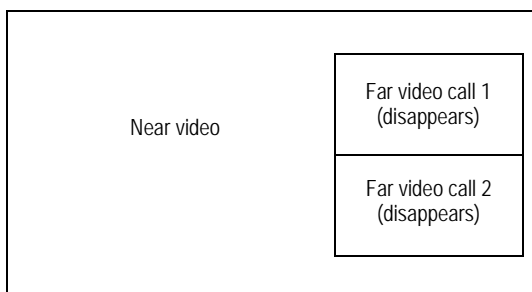

## Four-way Call

### Layout 1/5

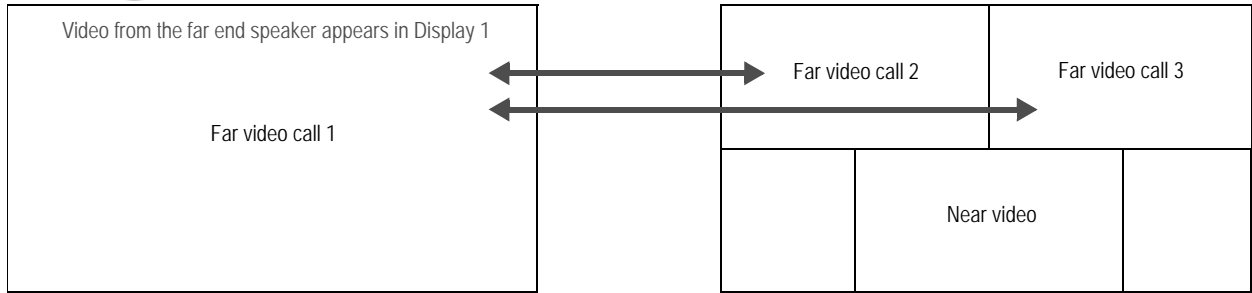

### Layout 2/5

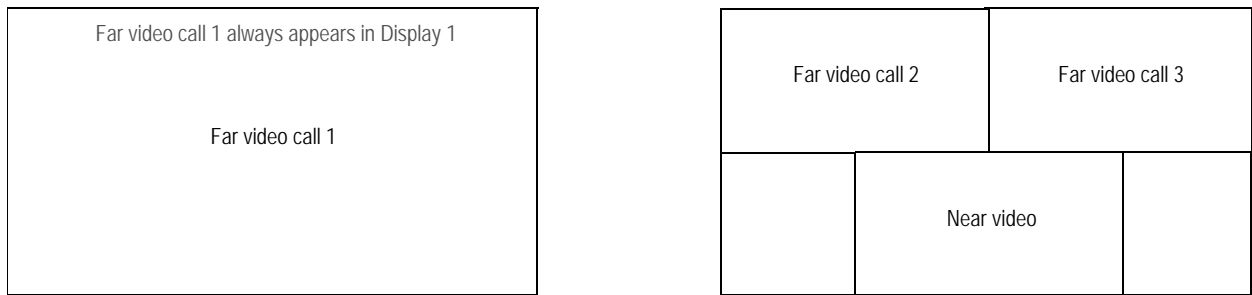

### Layout 3/5

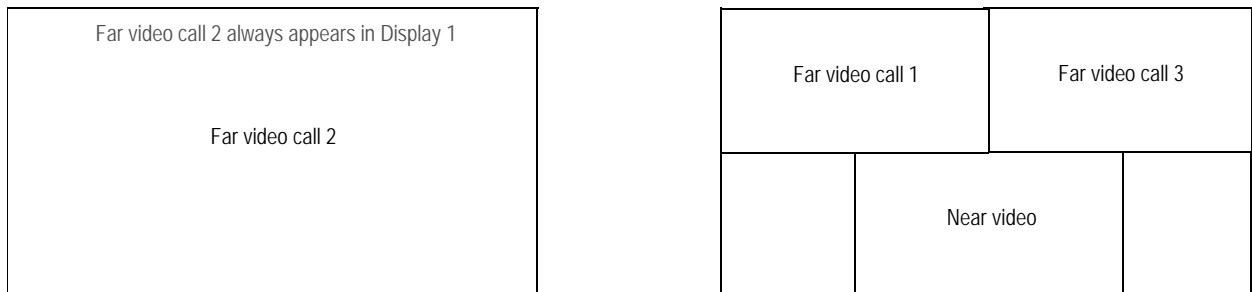

### Layout 4/5

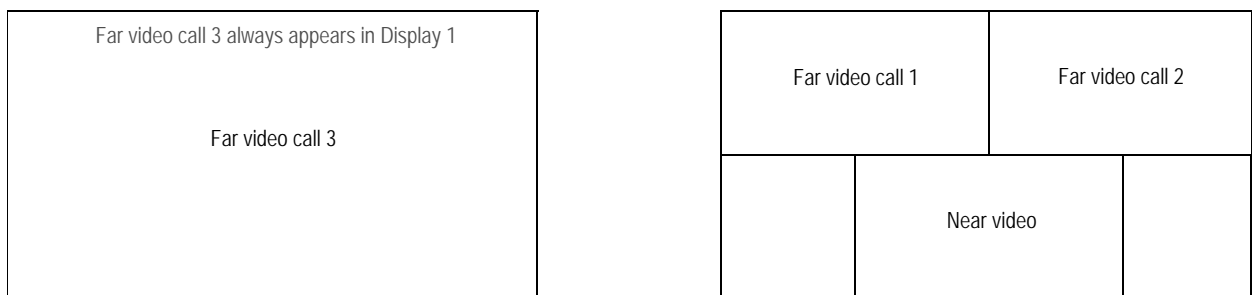

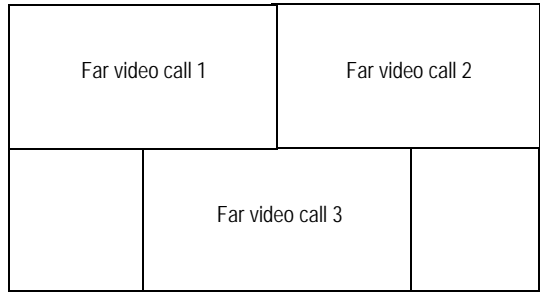
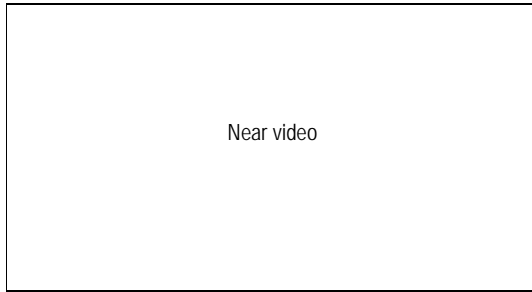

Layout 5/5

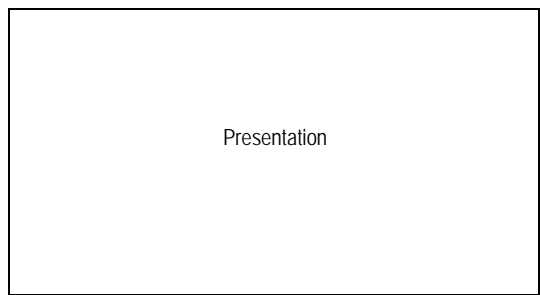
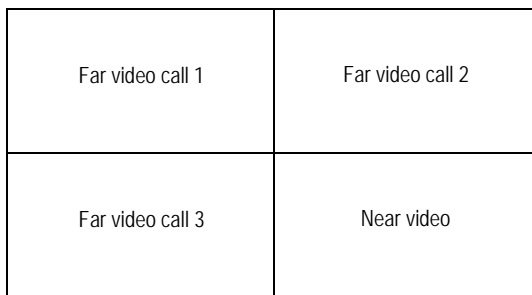

### Four-way Call with Presentation

Layout 1/8



Layout 2/8 

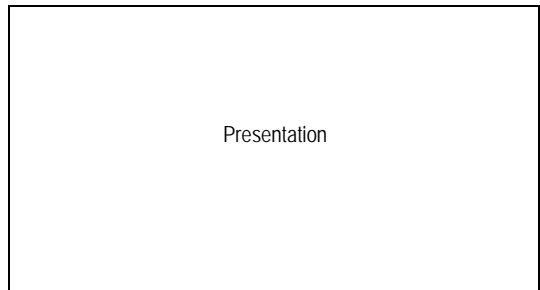
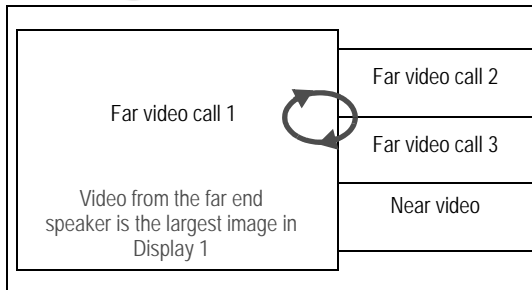

Layout 3/8

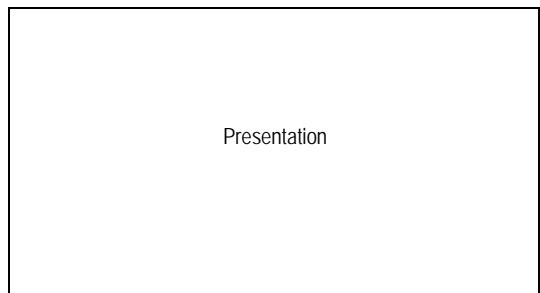
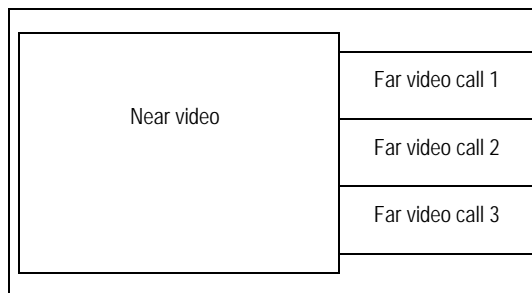

Layout 4/8 

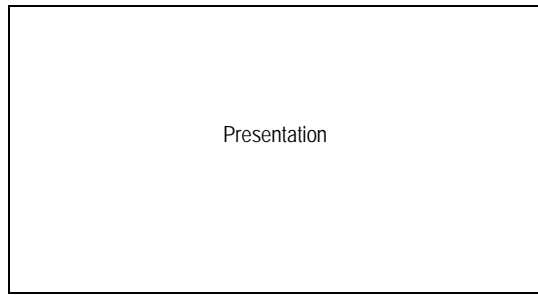
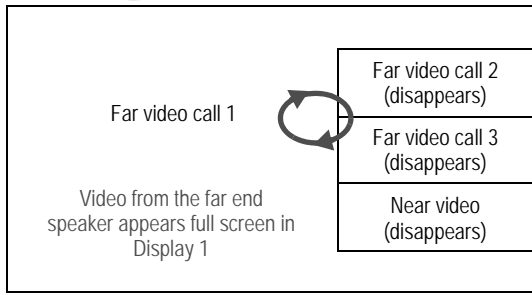

Layout 5/8

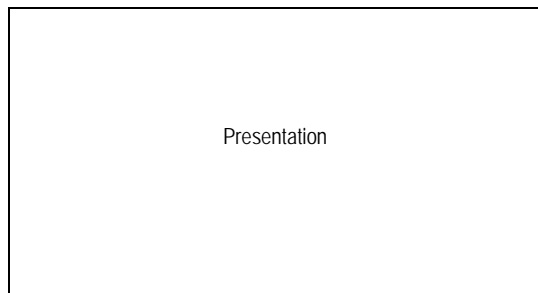
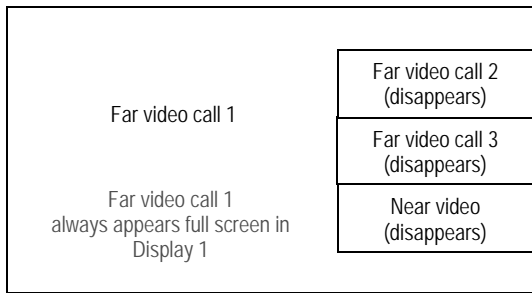

Layout 6/8

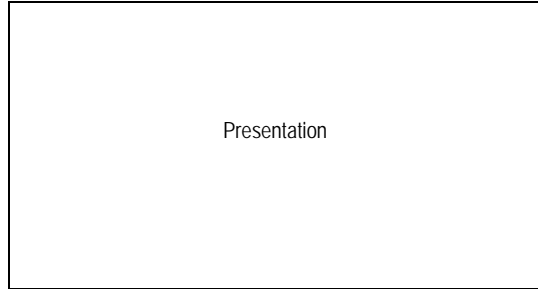
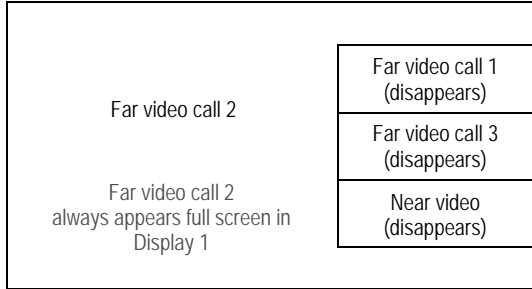

Layout 7/8

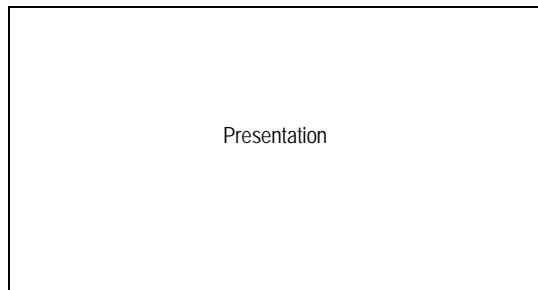
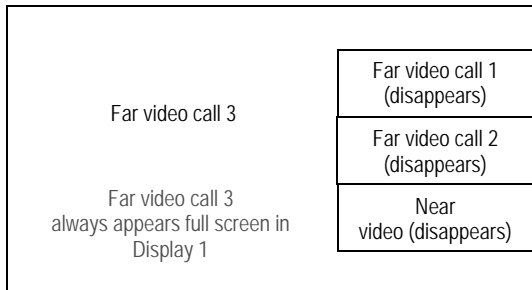

Layout 8/8

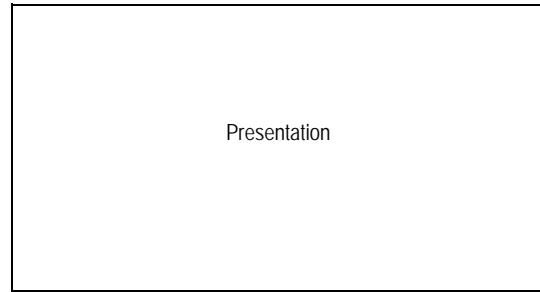
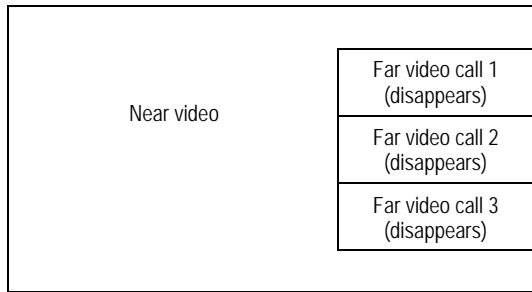



## Changing Video Inputs

Change the primary and presentation inputs when the system is idle or during a call.

### Changing the Primary Input

1. Do one of the following:





- When the system is idle and the main screen appears in the display, press **input**  +  on the remote control.
- During a call, press **input** .

The **Primary Input** selection dialog box contains small representations of the available input sources.

2. Use the arrow keys to select a new input and press **OK**.

### Changing the Presentation Input

1. Do one of the following:

- When the system is idle and the main screen appears in the display, press  +  +  on the remote control.
- During a call, press **input**  + .

The **Presentation Input** selection dialog box contains small representations of the available input sources.

2. Use the arrow keys to select a presentation input and press **OK**.

The default presentation input is named PC. Your administrator may have changed the name to identify a different default device or used a name that is more meaningful in your organization.



## Managing the REDIAL List

Manage an entry in the REDIAL list by selecting the entry and pressing  on the remote control. The following options are available:

<b>Save</b>	Adds the entry to the local directory.
<b>Remove</b>	Removes the entry from the REDIAL list.
<b>Lock</b>	Prevents the entry from being removed after the maximum number of entries in the list has been reached. The lock symbol  appears next to the name in the entry when the entry is selected. Locking an entry does not prevent it from being removed from the list manually.

Adjust the maximum number of entries in the **REDIAL** list by setting **User Preferences : Calls : Maximum Redial Entries**. Choosing *None* removes entries from the **REDIAL** list and prevents new entries from appearing on the list.



## Creating a Recording

With LifeSize Video Center configured in your environment, you may initiate a recording in and out of a call. Read more in the *LifeSize Video Center Administrator Guide*.

---

**NOTE** In-call recording is disabled if you are in an audio-only call.

---

1. *Out of Call Recording Only*: From the main screen, press .
2. Press .
3. If prompted, enter a valid recording key. If successful, the recording begins and the recording icon appears.
4. To end the recording, press . If in a call, ending the call also ends the recording.

## Advanced Camera Functions

### Configuring Camera Presets

A camera preset is a predefined camera position that is associated with a numeric key on the remote control. Camera presets enable you to quickly change the position of the near end camera during a call by pressing a single key on the remote control instead of using the arrow and zoom keys. Far end participants see the video image without the delay that is associated with using more than one key to position the camera.

You can save nine presets through the remote control. When presets are available for use, icons for the numeric keys (0 through 9) followed by the word **Presets** appear in the navigation bar.



Configure and use presets in the **Primary Input** and **Presentation Input** screens before placing a call as follows:

1. Press **near/far**  to select the near end camera and then adjust its position.
2. Press and hold a numeric key (1 through 9) on the remote control until **Preset x saved** appears above the status bar. The current position of the camera is associated with the numeric key.

If you choose a numeric key that already has a preset configured, it is overwritten. If an existing preset associated with the key is locked, **Preset x locked** appears. The 0 key, when used as a preset, always moves the selected camera to the default position and cannot be overwritten.

3. To test the preset, use the arrow keys to move the camera to a different position and press the numeric key associated with the preset to move the camera to the preset position. **Preset x** appears above the status bar.

## Using Camera Presets During a Call

1. If not already selected, press **near/far**  to select the near end camera.
2. Ensure that **Presets** appears to the right of the numeric keys icons in the navigation bar from any call screen. If **Touch Tones** appears instead, change the function of the keys to **Presets** by pressing .
3. Press the numeric key on the remote control that represents the preset you wish to use. **Preset x** appears on the screen.

If you configured a preset for a far end camera in the call, you must select the far end camera to use the preset. Refer to [Controlling a Far End Camera](#).

---

**NOTE** During a call, the numeric keys work as presets only from a call screen.

---

## Locking Camera Presets

By default, all users can configure camera presets. To prevent all users (near and far end) from configuring camera presets, administrators can set **Administrator Preferences : Video : Video Control : Camera Presets Lock** to *Locked*. To prevent only far end users from configuring camera presets, set **Far Control of Near Camera** or **Far Set of Camera Presets** to *Disabled*.

## Using Digital Zoom

Digital zoom electronically crops an area of the video image that appears in the display using the same aspect ratio as the original image and then scales the cropped image to the dimensions of the original image. Digital zoom is available with your LifeSize camera connected to LifeSize Room 220 and LifeSize Team 220 through firewire.

---

**NOTE** By default, digital zoom is disabled. Only administrators can enable this feature.

---

If you are using digital zoom with LifeSize Camera 200, consider the following:

- LifeSize Camera 200 must be connected to the codec through firewire, not HDMI.
- Digital zoom is available with LifeSize Camera 200 only after the camera's longest focal length with optical zoom has been reached.
- Camera presets are not supported with LifeSize Camera 200 while using digital zoom. Using a camera preset while in digital zoom returns the camera to optical zoom.

---

NOTE Image quality may degrade when using digital zoom.

---

To use digital zoom, do the following:

1. Ensure that the camera is selected as the primary video input. Read more at [Changing Video Inputs](#).
2. Select the camera you wish to control by pressing **near/far** .  
  
During a call, the near camera is selected by default. An orange and white camera icon appears in the near video image when the user interface is visible and the near end camera is selected.
3. Depending on the camera you are using, do one of the following:
  - *LifeSize Focus*: Press the zoom in button on the remote control to obtain a closer view of the near end video image.
  - *LifeSize Camera 200*: Press and hold the zoom in button on the remote control until you reach the longest focal length with the camera's optical zoom. Release the zoom in button. Press the zoom in button again to use digital zoom.
4. Use the arrow keys on the remote control to digitally pan and tilt the camera. Depending on the camera you are using, digital pan and tilt behave as follows:
  - *LifeSize Focus*: Digital pan and tilt are available only after you activate digital zoom by pressing the zoom in button. If you exit digital zoom by using the zoom out button to return to the camera's original fixed focal length, digital pan and tilt are not available.
  - *LifeSize Camera 200*: Digital pan and tilt are available only when using digital zoom and only after the camera's mechanical limits of pan and tilt have been reached.
5. Use the zoom out button to view the image from farther away or to exit digital zoom.

## Working with Directories

The directory includes three subdirectories:

<b>Local</b>	Single entry with dialing information for a single device.
<b>Corporate</b>	Read-only entry with dialing information for a single device.
<b>Meetings</b>	Single entry with dialing information for one or multiple devices. When you place a call, the system dials all the devices in the entry.

### Placing a Call from the Directory

1. From the main screen, press  to access the directory.
2. Use the arrow keys to select the **Local**, **Corporate**, or **Meetings** directory and press **OK**.

---

**NOTE** If an entry in the local or corporate directory has more than one number, the  symbol appears in the **NUMBERS** column. Press **OK** and select the number you wish to call. Press **OK** to place the call.



---

3. Use the arrow keys to select the entry that you wish to dial.
4. Press **OK** to place the call.

### Browsing the Directory

Browse the directory using the alphabetical or hierarchical method. When you use the alphabetical method, the entries appear in alphabetical order and you can select an alphabet group in the **Browse** column to quickly navigate to an entry.

Hierarchies are predefined organizational units similar to folders or directories on a computer system. Place an entry into a hierarchy when you create the entry or at any time by editing the **Hierarchy** field. Using the hierarchical method, select a hierarchy in the **Browse** column to locate an entry.

To move down one level in **Browse**, press **OK**. To move up one level, press . Use the  and  buttons to move up or down a page of entries when an entry is selected.

### Adding an Entry to the Local or Meetings Directory



Create up to 1000 entries in the local directory and 100 entries in the meetings directory.

1. From the main screen, press  to access the directory.
2. Using the arrow keys, select the **Local** or **Meetings** directory.
3. Select **Add New Entry** and press **OK**.

4. Do one of the following:

- *Local directory:* Use the arrow keys to select fields in the **New Directory Entry** screen. Press **OK** to enter a value in a selected field. Enter a system name, video and voice numbers, and IP address or ISDN numbers.

---

**NOTE** If necessary, press  to change the method of text entry for text fields or press  to access the keyboard. After entering a value, hide the keyboard if you used it to enter the value and press **OK** to exit the field.

---

- *Meetings directory:* Select **Meeting Name** and press **OK**. Enter a name for the meeting.

Select the directory (**Local**, **Corporate**, or **Both**) from which you wish to choose entries to add to the meeting.

In the **Available Entries** column, select an entry to add to the **Participants** column and press **OK**.



If the entry has more than one number, a submenu that contains each number appears. Select the number on the submenu that you wish to dial for the meeting and press **OK**. Select an entry from the **Available Entries** column for each participant that you wish to add to the meeting entry.

5. *Predefined hierarchy:* In the **Hierarchy** field, enter the path for the entry's location in the hierarchy. Hierarchies can be defined by location or department. You must identify the full path (separated by commas) of a predefined hierarchy in which to add an entry before you leave the new entry screen. If you leave the **Hierarchy** field empty, the new entry is inserted at the top of the hierarchy (if defined) or grouped alphabetically.

Suppose your administrator defined a hierarchy by location where Home Office is the top of the hierarchy and Sales Office 1 and Sales Office 2 are at the next level below the Home Office. To place an entry in Sales Office 2, the value for **Hierarchy** is *Home Office,Sales Office 2*.

6. Select **Add Entry** (or **Add Meeting**) and press **OK**.

## Copying, Removing, and Editing Entries

Copy, remove, or edit an entry by accessing the directory ; selecting the entry; and pressing . Depending on the entry, the following options may be available:

<b>Copy to local</b>	When you access the corporate directory, you can copy an entry to the local directory.
<b>Remove</b>	Selecting this option removes the entry from the local or meetings directory.
<b>Edit</b>	Modify values in the <b>Edit Directory Entry</b> or <b>Edit Meeting Entry</b> dialog box. If necessary, press  to change the method of text entry for text fields.

## Section 2: Configuring LifeSize Video Communications Systems

This section describes how to administer your LifeSize video communications system.

<b>Initial configuration</b>	At installation, your LifeSize system prompts you to configure basic required settings. Initial configuration screens also appear after you restore the system to default settings. Read more at <a href="#">Initial Configuration</a> .
<b>Passwords</b>	Manage user and administrator passwords. Read more at <a href="#">Administrator and User Passwords</a> .
<b>System management</b>	Manage your system with the remote control; through a browser, SSH, or Telnet session; with MIBs; or with LifeSize Control. Learn more at <a href="#">Managing Your System</a> .
<b>Network</b>	Configure network preferences. Read more at <a href="#">Configuring Network Usage</a> and <a href="#">Configuring your LifeSize System for Firewall Traversal</a> .
<b>Appearance</b>	Configure video layout and display preferences. Read more at <a href="#">Configuring Appearance</a> .
<b>Calls</b>	Manage call bandwidth and set a maximum call time. Read more at <a href="#">Configuring Call Preferences</a> .
<b>Communications</b>	Control the protocols the system uses during calls. Read more at <a href="#">Configuring Communications Preferences</a> .
<b>Audio</b>	Select the active microphone and adjust audio input and output. Read more at <a href="#">Configuring Audio Behaviors</a> .
<b>Video</b>	Control cameras and video quality. Read more at <a href="#">Configuring Video Behaviors</a> .
<b>Security</b>	Enable FIPS 140-2 and H.235 AES security. Read more at <a href="#">Security Preferences</a> .
<b>Directories</b>	Manage the local, corporate, and meetings directories. Read more at <a href="#">Directories</a> .
<b>Interface lock</b>	Lock the interface and cameras. Read more at <a href="#">Locking the Interface</a> .
<b>Maintenance and upgrade</b>	Learn how to upgrade system software; update license keys; and restore a system to its default settings at <a href="#">Maintaining Your System</a> .

---

**NOTE** Administrator functionality is password protected.

---

# Initial Configuration

At the end of the installation process, your LifeSize system prompts you to configure preferences required for the system to start. The initial configuration screens also appear when you perform a system reset.

Read more at [Restoring Default Settings](#).

<b>Language</b>	Select the language to display in the user interface. The default is English.
<b>Passwords</b>	Manage the administrator and user passwords. Read more at <a href="#">Administrator and User Passwords</a> .
<b>System identification</b>	Set the location, time zone, system name, video number, and voice number.
<b>Communications</b>	Select the video and voice protocols. Read more at <a href="#">Configuring Dialing Options</a> .
<b>Network</b>	<p>By default, DHCP is enabled on LifeSize systems. If you disable DHCP, you must specify the system's IP address, subnet mask, and default gateway. Read more at <a href="#">Specifying a Locally Configured IP Address</a>.</p> <p>Enter the hostname of the system and the IP addresses to configure DNS servers if you do not have a DHCP server that automatically sets a DNS server. Read more at <a href="#">Specifying the Hostname and DNS Servers</a>.</p> <p>If you set the network speed, ensure that the option matches the speed and duplex configured on your network switch. Read more at <a href="#">Specifying Network Speed</a>.</p> <p>The system shows the date and time automatically with DHCP enabled or when you specify the hostname or IP address of an NTP server. Read more at <a href="#">Specifying an NTP Server</a>.</p>
<b>Audio</b>	<p>By default, the system detects attached audio input devices and selects the active microphone. To adjust audio preferences, refer to the following:</p> <ul style="list-style-type: none"> <li>• <a href="#">Selecting the Active Microphone</a></li> <li>• <a href="#">Adjusting the Active Microphone Volume</a></li> <li>• <a href="#">Selecting Audio Output</a></li> <li>• <a href="#">Testing primary audio output</a></li> </ul>

---

**NOTE** After initial configuration, manage these preferences from the main interface; through the web administration interface; or from the command line. Read more at [Managing Your System](#).

---

## Administrator and User Passwords

Change the user and administrator passwords during initial configuration or in **Administrator Preferences : Security : Passwords**. Passwords can be up to 16 characters in length and contain any combination of the numbers 0-9 and the symbols \* (star) and # (pound).

The default administrator password is 1 2 3 4. LifeSize recommends that you protect the administrator preferences with a secure password.

Set a user password to control access to **User Preferences** screens. By default, the user password is not set. If you set a user password, you can also access the **User Preferences** screens with the administrator password.

## Enabling Communication with Other Systems

Depending on your environment, you may need to make the following additional adjustments to the configuration of your LifeSize system and your network after installing, but before using, the system.

<b>Static NAT</b>	If you choose to place your video communications systems in a private LAN, you must use Network Address Translation (NAT) to communicate with outside systems. This may include enabling static NAT on your LifeSize system. Read more at <a href="#">Using LifeSize Systems in a Private LAN with NAT</a> and <a href="#">Enabling NAT</a> .
<b>Firewall</b>	If your LifeSize system communicates with other devices through a firewall, you must configure your firewall to allow incoming and outgoing traffic to the LifeSize system through reserved and required ports. Users placing calls through a firewall to systems with IP addresses may experience one-way audio or video if the firewall is not properly configured to allow video and audio traffic. Read more at <a href="#">Configuring your LifeSize System for Firewall Traversal</a> .
<b>H.323</b>	If you are using H.323 gatekeepers in your environment and want to place calls using a name or extension with the H.323 protocol, configure your LifeSize system using the information in <a href="#">Configuring H.323 Settings</a> .
<b>SIP</b>	If you are using Session Initiation Protocol (SIP) servers in your environment to place calls using the SIP protocol, configure your LifeSize system using the information in <a href="#">Configuring SIP Settings</a> .

## Placing a Test Call to LifeSize Systems

LifeSize Demo (demo.lifesize.com) appears as a default entry in the **REDIAL** list and local directory for a new system and a system that is restored to default settings. Use this entry to place a test call from your LifeSize system.



---

**NOTE** To use this entry, you must specify a DNS server in **Administrator Preferences : Network : General** or use DHCP that automatically sets a DNS server. If a DNS server is not configured, a call to this entry shows the call status as unavailable, because the call cannot resolve to the IP address.

---



## Managing Your System

<b>Remote control</b>	<p>To configure your LifeSize system with the remote control, follow these steps:</p> <ol style="list-style-type: none"> <li>1. From the main screen, press  to access the <b>System Menu</b>.</li> <li>2. Select <b>Administrator Preferences</b> and press <b>OK</b>.</li> <li>3. Enter the administrator password (by default, 1 2 3 4) and press <b>OK</b>.</li> </ol> <p>If you enter an incorrect password, press  to clear the error message.</p>
<b>Browser</b>	<p>To configure your LifeSize system from a web browser, you must have Adobe Flash Player installed and configured on your web browser.</p> <ol style="list-style-type: none"> <li>1. Open a web browser and enter the IP address of the LifeSize system. The IP address of the system appears at the top of the main screen.</li> <li>2. Enter the administrator password and click <b>Submit</b>. This is a secure Internet connection and you may receive an unknown certificate warning.</li> </ol> <p>By default, remote access to a LifeSize system through a web browser is enabled. To disable remote access through a web browser, set <b>Administrator Preferences : Security : General : HTTP</b> to <i>Disabled</i>.</p>
<b>SSH</b>	<p>Log in through an SSH session and enter commands to manage your LifeSize system remotely. By default, remote access through SSH is enabled. To disable remote access through SSH, set <b>Administrator Preferences : Security : General : SSH</b> to <i>Disabled</i>.</p>
<b>Telnet</b>	<p>Use the command line interface to manage the system through a telnet session.</p> <p>LifeSize recommends that you use the web administration interface or an SSH session to manage your system remotely. By default, remote access through a telnet session is disabled. To enable remote access through a telnet session, set <b>Administrator Preferences : Security : General : Telnet</b> to <i>Enabled</i>.</p>
<b>LifeSize MIBs</b>	<p>By default, LifeSize video communications systems are SNMP-enabled devices that support SNMPv3. With a LifeSize custom MIB compiled on your SNMP manager and an SNMP user configured on your LifeSize system, you can monitor and configure LifeSize video communications systems from your SNMP manager console.</p> <p>LifeSize MIBs are available for download as ASCII text files at <a href="http://lifesize.com/support">lifesize.com/support</a>.</p> <p>By default, remote access to a LifeSize system through SNMP is enabled. To disable remote access through SNMP, set <b>Administrator Preferences : Security : General : SNMP</b> to <i>Disabled</i>.</p>
<b>LifeSize Control</b>	<p>With LifeSize Control, administrators can manage video systems across the enterprise. LifeSize Control features include resource scheduling, monitoring, reporting, and remote upgrading.</p>

## Viewing Recent Configuration Changes

To quickly access a preference that has been recently changed, navigate to **Administrator Preferences : Recent**. Preferences that have dependencies on other preference settings, such as H.323 and SIP server preferences, may not appear in **Recent**.

---

**NOTE** Upgrading the system software removes all preferences from **Recent**.

---

## Configuring Network Usage

Configure preferences that affect how your LifeSize system functions with other servers and devices on your local network in **Administrator Preferences : Network : General**. As you configure network preferences, consider the following:

- Changing the option for a preference in **Administrator Preferences : Network** takes effect only after you navigate to a different screen.
- A LifeSize video communications system cannot detect a change to its IP address if the change is due to a change in networks from a wiring closet or through software, such as a change to a router configuration. Reboot the LifeSize system if the DNS changes.

### Specifying a Locally Configured IP Address

Dynamic Host Configuration Protocol (DHCP) is used to dynamically allocate and assign IP addresses. DHCP allows you to move network devices from one subnet to another without administrative attention. You can choose to enable DHCP if a DHCP server is present.

If you disable DHCP, you must enter the following:

IP address	Locally configured IP address if not assigned by a DHCP server
subnet mask	Used to partition the IP address into a network and host identifier
gateway	IP address of the default gateway the system uses

### Configuring LifeSize Systems Using DHCP

If a LifeSize video communications system obtains its IP address using DHCP, it can accept an option from the DHCP server that specifies a location and file from which the system can obtain configuration information. The file can be located on a web server, trivial file transfer protocol (TFTP) server, or file transfer protocol (FTP) server. Each time the system boots, it attempts to fetch the configuration file specified by the option. If the configuration file changed since the last time it was applied, the system applies the configuration file before the boot process continues. The following prerequisites must be met to enable this feature:

- The **DHCP** preference in **Administrator Preferences : Network : General** on the LifeSize system must be set to *Enabled*.
- A LifeSize system accepts site-specific option 157 for this feature. You must configure this option on the DHCP server.

---

**NOTE** If you configure a system using DHCP option 157 and specify a TFTP server as the source from which to obtain the configuration file, the system accepts the download through port 5351. Ensure that firewalls between the system and the TFTP server are configured to allow the download through this port.

---

- A configuration file that contains LifeSize command line interface commands must exist at the location specified by the DHCP option. Read more at [Saving and Restoring a System Configuration](#).

## Configuring the DHCP Option

Specific configuration details of DHCP servers for use with this feature vary depending on the DHCP server used and your environment.

A LifeSize system can accept site-specific option 157 from the DHCP server if you configure the option as a string with the following format:

```
"LifeSize: server=<path>"
```

where *<path>* is a URL that specifies the configuration file location. Separate multiple URLs with a semicolon. Supported protocols include TFTP, FTP, and HTTP. If the path contains more than one URL, the LifeSize system tries the URLs in the order listed and uses the first file that exists.

For example, if the path is the following:

```
http://example/config/fishtank.cfg;ftp://example/other/fishtank.cfg
```

the system attempts to obtain the configuration file `fishtank.cfg` from the web server at `http://example/config/fishtank.cfg`. If the file does not exist at that location, the system attempts to obtain the configuration from the FTP server at `ftp://example/other/fishtank.cfg`.

If the server requires a username and password to access the file (for example, to log into an FTP server), you can include the username and password in the URL. For example:

```
ftp://<username>:<password>@example/other/fishtank.cfg
```

where *<username>* is the user name and *<password>* is the password required for the login. The user name and password must not contain a semicolon.

Each URL can also contain the following escapes to make the configuration unique to the system:

Escape	Replacement Value
#M	Replaced with the MAC address. Use the underscore character to replace the colon between bytes. The MAC address resolves to a hexadecimal number with lowercase letters.
#S	Replaced by the system model: room220, team220, or express220
#I	Replaced by the assigned IP address.

If a machine name or IP address is used alone as a path element, the following path is substituted:

```
tftp://<name>/#M.cfg;tftp://<name>/#S.cfg
```

where *<name>* is the IP address or DNS name in the path.

For a LifeSize Room 220 system with a MAC address of 00:13:FA:00:12:33 and an IP address of 10.10.22.77, the following path resolves to search for a configuration file at the following four locations:

```
http://example/configs/fishtank.cfg;example;ftp://example/#I.cfg
```

1. `http://example/configs/fishtank.cfg`
2. `tftp://example/00_13_fa_00_12_33.cfg`
3. `tftp://example/room220.cfg`
4. `ftp://example/10.10.22.77.cfg`

---

**NOTE** In the previous example, the MAC address 00:13:FA:00:12:33 is replaced with 00\_13\_fa\_00\_12\_33.

---

The first file found is used. If the checksum of the file is different from the last configuration file loaded into the system, the new file is used.

---

**NOTE** Setting preferences that result in a system reboot (for example, port ranges or SIP preferences), may cause the system to reboot when the configuration file is loaded into the system. Because the checksum for the configuration file in this case is the same, the file is not loaded again. The actual configuration changes are applied when the system is fully booted. This may cause previous configuration preferences to appear in the user interface (for example, a previous system name) before the configuration takes effect.

---

A configuration file consists of a series of command line interface commands in the same format as the output from the `get config` command or in a configuration file created by saving the system configuration from the web administration interface. Read more at [Saving and Restoring a System Configuration](#).

## Specifying the Hostname and DNS Servers

Enter the hostname of the system and the IP addresses to configure Domain Name Service (DNS) servers in **Administrator Preferences : Network : General : Hostname** and **DNS Servers**. DNS translates names of network nodes into addresses. Specify this preference to use DNS to resolve the hostnames of devices to IP addresses. You can also enter the domain names to search when resolving hostnames in **Name Search Domains**.

## Specifying Network Speed

If you choose an option other than *Auto* for **Administrator Preferences : Network : Network Speed**, ensure that it matches the speed and duplex configured on your network switch.

If your Ethernet switch is configured for half duplex, you may experience poor quality video when placing calls greater than 512 kb/s. Change your Ethernet switch configuration to a setting other than half duplex when using *Auto* for **Network Speed**.

## Specifying a VLAN Tag

If you have static virtual local area networks (VLANs) configured in your environment, configure your LifeSize system to apply a VLAN tag to outgoing packets and accept only incoming tagged packets that have the same VLAN identifier. Specify the VLAN identifier of the VLAN to which the system is assigned in **Administrator Preferences : Network : General : VLAN Tag**. The value is a number in the range 1 through 4094.

If you set or modify **VLAN Tag**, the system reboots when you navigate to another screen.

## Configuring 802.1X Authentication

LifeSize video communications systems support port-based mutual authentication based on the IEEE 802.1X standard using the EAP-TLS sub-protocol.

By default, 802.1X authentication is disabled on a LifeSize system. Before you enable this feature in **Administrator Preferences : Network : General : 802.1x Authentication**, ensure that your environment meets the following prerequisites:

- An authentication server is installed with the CA certificate, the server certificate, and the server certificate private key.
- The authenticator is configured to access the authentication server and to allow one or more of its ports to provide 802.1X access control.
- A certificate authority has produced a CA certificate, a client certificate, a client key and a client key passphrase for the LifeSize system and you have installed these certificates, key, and key passphrase on the LifeSize system using the required commands in the LifeSize command line interface.

---

**NOTE** If you do not install the CA certificate, client certificate, client key, and client key passphrase on the LifeSize system from the command line interface before enabling 802.1x, the LifeSize system fails to connect to the network when you enable 802.1x. In this case, access the system to disable the feature through the user interface.

---

## Specifying an NTP Server

The system date and time appear in the user interface and are automatically set if one of the following conditions exists:

- **Administrator Preferences : Network : General : DHCP** is enabled and the DHCP server can pass an NTP server address to your system.
- or -
- **Administrator Preferences : Network : General : NTP Server Hostname** specifies the hostname or IP address of an NTP server.

---

**NOTE** An NTP server address that a DHCP server passes to your system overrides an NTP server hostname or address specified in **NTP Server Hostname**.

---

The **System Information** page shows the IP address of the NTP server that the system uses.

The time zone is not set automatically. If you did not specify the time zone for your system during the initial configuration, the time that appears in the user interface may not be correct. Specify the time zone in **Administrator Preferences : System : Date and Time**.

## Enabling IPv6 Addressing

LifeSize systems support dual configuration of IPv4 and IPv6 addressing for the system IP address only. You cannot disable IPv4 addressing on your system. Enable IPv6 addressing in **Administrator Preferences : Network : General : IPv6**.

---

**NOTE** Calls placed with an IPv6 address use the H.323 protocol. IPv6 addressing is not supported with the SIP protocol.

---

If your IPv6 network sends router advertisements, select *Auto* for **IPv6 Configuration** to automatically assign the IPv6 address to the system. If you set **IPv6 Configuration** to *Manual*, you can specify a static IPv6 address for the system and the address of your IPv6 router.

---

**NOTE** Enabling or disabling IPv6 causes the system to reboot when you navigate to another screen.

---

The IP address that appears at the top of the main screen is the IPv4 address. The IPv6 address of the system appears in the **System Menu** on the **System Information** page.

All other configuration preferences that require an IP address must be IPv4 addresses; for example, the NTP and DNS servers, H.323 gatekeeper, and SIP server.

The directory supports IPv6 addresses. Users can also manually dial IPv6 addresses using the **Video Call** or **Voice Call** buttons on the main screen of the user interface and the **0x1a** text entry method or screen keyboard. Before placing the call, press  to change the text entry method to **0x1a**.

## Configuring Quality of Service

Specify network Quality of Service (QoS) settings in **Administrator Preferences : Network : Network QoS**. Set these preferences according to the settings used in your network.

# Configuring your LifeSize System for Firewall Traversal

This section explains how to configure your LifeSize video communications systems for firewall traversal, assuming you are not using firewall traversal products such as LifeSize Transit. If you are using LifeSize Transit, refer to the *LifeSize Transit Deployment Guide*.

## Placement Behind a Firewall

LifeSize recommends that you place your system behind a firewall. Use one of the following options:

<b>DMZ with public IP address</b>	Placing your video systems in the DMZ allows you to assign public IP addresses. This configuration makes it easier for your system to connect with public video communications devices on the Internet.
<b>Private LAN with NAT</b>	Placing your video systems in the private LAN with Network Address Translation (NAT) obscures their private IP addresses, but makes calls with systems outside of your network more complicated.

## Firewall Settings for Ports

At a minimum, block external or inbound access to the following ports:

- 22 (SSH)
- 23 (Telnet)
- 80 (HTTP)
- 443 (HTTPS)

LifeSize recommends that these ports remain open for internal administrator access. Ensure that you change the default administrator and command line interface (CLI) passwords to be secure. Change the administrator password in **Administrator Preferences : Security : Passwords**. Read more at [Administrator and User Passwords](#). Use the `set password` command to change the CLI password; the default CLI password is `lifesize`.

You can disable SSH and web access on the system. Telnet access is disabled by default. Read more at [Managing Your System](#).

## Call Setup and Media Ports

To place calls to other systems through the firewall, you must configure your firewall to allow incoming and outgoing traffic to the system through the following:

TCP port 1720	H.323 call negotiation
UDP port 5060	SIP call negotiation
TCP port 5060	SIP call negotiation if TCP signaling is enabled for SIP calls. Refer to <a href="#">Configuring SIP Settings</a> .
TCP port 5061	TLS signaling in SIP calls if TLS signaling is enabled. Refer to <a href="#">Configuring SIP Settings</a> .
Required TCP and UDP ports	Range specified in <b>Administrator Preferences : Network : Reserved Ports</b> .

## Restricting Reserved Ports

To place calls to other devices through a firewall, you must configure your firewall to allow incoming and outgoing traffic to the LifeSize system through the reserved ports. Users placing calls through a firewall to systems with public IP addresses may experience one-way audio or video if the firewall is not properly configured to allow two-way video and audio traffic.

By default, LifeSize systems communicate through TCP and UDP ports in the range 60000 - 64999 for video, voice, presentations, and camera control. LifeSize systems use only a small number of these ports during a call. The exact number depends on the number of participants in the call, the protocol used, and the number of ports required for the type of call: video or voice.

To minimize the number of UDP and TCP ports that are available for communication, restrict the range by changing values in **Administrator Preferences : Network : Reserved Ports**. LifeSize recommends that the range you choose, if other than a subset of the default range, begins with a port number greater than 10000. The UDP range must start with an even number and end with an odd number to include an even number of total ports. For a range that starts at 62000, set the lower end to 62000 and the upper end to 62055 to allocate a range of 56 ports.

---

**NOTE** Changing the TCP range causes an automatic reboot of the system.

---

The following tables identify the number of ports required per connection by protocol and the type of call.

Required ports for an H.323 two-way call:

Call Type	Number of Required UDP and TCP Ports
Video <sup>a</sup>	8 UDP ports; 6 if presentations are disabled 2 TCP ports
Voice <sup>b</sup>	2 UDP ports 2 TCP ports

a. Each additional video participant requires 8 UDP and 2 TCP ports.

b. Each additional voice participant requires 2 UDP and 2 TCP ports.

Required ports for a SIP two-way call:

Call Type	Number of Required UDP Ports
Video <sup>a b</sup>	8 UDP ports; 6 if presentations are disabled
Voice <sup>c</sup>	2 UDP ports

a. Dual video with third party devices requires one additional port.

b. Each additional video participant requires 8 UDP ports.

c. Each additional voice participant requires 2 UDP ports.



Depending on the maximum number of connections that your LifeSize system supports, use the following information as a guide when determining the range of port numbers to enter in **Reserved Ports**.

System	Maximum Connections	Required Ports for an H.323 Call		Required Ports for a SIP call	
LifeSize Room 220	Eight-way video call and a presentation	56 UDP 14 TCP	60000 - 60055 60000 - 60013	56 UDP	60000 - 60055
LifeSize Team 220	Four-way video call and a presentation	24 UDP 6 TCP	60000 - 60023 60000 - 60005	24 UDP	60000 - 60023
LifeSize Express 220	Two-way video call with a presentation and an audio call	10 UDP 4 TCP	60000 - 60009 60000 - 60003	10 UDP	60000 - 60009

## Using LifeSize Systems in a Private LAN with NAT

If you choose to place your video communications systems in a private LAN, you must use NAT to communicate with outside systems. This may include enabling static NAT on your LifeSize system.

On your firewall, whether standalone or built into your router, you must do one of the following:

- Use one-to-one NAT and open the **Call Setup and Media Ports** over that connection bidirectionally with an access list.
- Forward the **Call Setup and Media Ports** to your LifeSize system.

Refer to **Restricting Reserved Ports** and your firewall vendor's documentation for more information.

### Enabling NAT

NAT enables communication between devices on your LAN that have private IP addresses and devices that are accessed through a public IP network. Static NAT ensures that the same public IP address always maps to a system's private IP address so that data from the public network intended for the private system can be routed to the system reliably.

If you are using static NAT to associate a public IP address with the private IP address of your LifeSize system, you must configure your LifeSize system to work with your static NAT server. Set **Administrator Preferences : Network : NAT : Static NAT** to *Enabled*. Enter the public IP address, hostname, or fully qualified domain name of your system in **NAT Public IP Address**. The default entry method for this preference is numeric. To enter text, press  to change the entry method to text.

The following functions are not supported if your system is accessed from a web browser outside a firewall and static NAT is enabled. Instead, execute these functions from within the firewall.

- system upgrade
- directory import
- LifeSize Networker upgrade and reboot
- background image import

## Testing your NAT Environment

If your firewall does not employ a feature set that performs H.323 or SIP NAT, you must enable NAT on your private LifeSize system.

1. Place a call from a system on the Internet to your system in the private LAN. If your private system connects within the first 2 seconds after answering, your NAT configuration is working properly. If the call does not connect after answering and disconnects after 30 to 50 seconds, the reserved port settings on your codec do not match the settings on your firewall. Ensure that the system and firewall settings for UDP/TCP ports match.
2. If you still cannot place a successful call, you may have to disable the stateful packet inspection feature on the firewall. Some firewall vendors may call this feature dynamic packet filtering. Refer to your firewall vendor's documentation for more information.

# Configuring Appearance

Configure how to display information on your system in **Administrator Preferences : Appearance**.

## Video Layout Preferences

Set the following preferences to manage the video layout:

Preference	Description	Default Value
<b>Picture In Picture</b>	With Picture In Picture (PIP) enabled, the primary input always appears. Change the default setting so that PIP never or always appears in <b>Administrator Preferences : Appearance : Layout</b> .	Auto
<b>Display 2 Layout</b>	By default, when you connect a second display to a LifeSize system that supports dual displays, a message instructs you to navigate to <b>Administrator Preferences : Appearance : Layout : Display 2 Layout</b> and select a configuration option. For information about configuring a second display, refer to the <i>LifeSize Video Communications Systems Installation Guide</i> .	None
<b>Multiway Call Layout</b>	<i>LifeSize Room 220 Only:</i> For multiway video calls, choose a screen layout that displays video from up to four callers; or a layout that displays video only from the caller who is currently speaking. Read more at <a href="#">Multiway Call Layout of Video Images</a> .	All Callers

### Multiway Call Layout of Video Images

LifeSize Room 220 supports multiway video calls that can show video from a maximum of four callers: three far end participants and the near end participant. Set the layout for multiway calls in **Administrator Preferences : Appearance : Layout**.

If **Multiway Call Layout** is set to the default of *All Callers*, video from up to four participants appears: the last three far end speakers and the near end participant. The video image from an additional far end participant who joins the call appears in the display only when that participant becomes the current speaker and replaces the video image of the earliest far end speaker.

*LifeSize Room 220 as MCU:* With **Multiway Call Layout** set to *Last Speaker*, the system transmits video only from the current speaker to all participants in the conference and transmits the video from the last speaker to the participant who is currently speaking. You must enable this feature before placing or receiving the first call in the conference.

---

NOTE *Last Speaker* is supported with H.323 and H.460 calls only.

---

You cannot change **Multiway Call Layout** during a call. LifeSize recommends that **Multiway Call Layout** is set to *All Callers* when you are not using the system as the MCU in a call.

---

**NOTE** With **Multiway Call Layout** set to *Last Speaker*, virtual multiway is not supported. Virtual multiway allows LifeSize systems in a call hosted by another LifeSize system to manage video in the call as the host, including managing layouts; controlling the far end camera; and viewing call information. Read more at [Virtual Multiway](#).

---

## Display Preferences

Specify display types, resolutions, and energy management options in **Administrator Preferences : Appearance : Displays**. Typically, you configure display types and resolutions when you install your system or change a display and when you troubleshoot display issues. Refer to the *LifeSize Video Communications Systems Installation Guide* for more information.

---

**NOTE** If a video input device (other than your LifeSize camera) is connected to an HD or component input on your LifeSize system, ensure that the display resolution selected in **Administrator Preferences : Appearance : Displays** matches the resolution on the input device. Mismatched resolutions can result in video transmitted to the far side at 720p30.

---

Set **Display Energy Saver** to *Enabled* for connected displays to turn off the signal that the LifeSize system sends to the display when the system goes to sleep. LifeSize recommends that you test this feature for compatibility with your displays before using it in your environment. Some displays may appear black when the signal from the system is no longer received, but not enter an energy saving state. Other displays may recognize the loss of the signal and show text indicating this state. This may result in the text image burning into the screen. Some displays may recognize the loss of the signal and power off, but then not wake up when the LifeSize system wakes up.

## Hiding User Interface Elements

Hide the following user interface elements in **Administrator Preferences : Appearance : General**.

Preference	Description	Default Value
<b>Company Logo</b>	Choose <i>None</i> to hide the LifeSize logo in the user interface and screen saver. The <i>Default</i> option shows the logo.	Default
<b>Hide IP Addresses</b>	When enabled, hides IP addresses from the following areas of the user interface: <ul style="list-style-type: none"> <li>• local IP address at the top of the screen</li> <li>• local IP address on the <b>System Information</b> page</li> <li>• IP addresses for systems in the REDIAL list</li> <li>• caller's IP address in the <b>Incoming Call</b> dialog box</li> <li>• caller's IP address in the <b>Caller ID</b></li> </ul> NOTE: To hide IP addresses on all ends of a call, all systems in the call must enable <b>Hide IP Addresses</b> .	Disabled
<b>Clear Last Number Dialed</b>	When enabled, clears the last number manually dialed from the main screen.	Disabled

To hide all IP addresses in the user interface, enable **Hide IP Addresses** and **Clear Last Number Dialed**.

## Custom Backgrounds

Manage the system's background from the user interface and the web administration interface.

### Specifying a Background Color

1. Navigate to **Administrator Preferences : Appearance : Backgrounds**.
2. Set **Background Image** to *None*.
3. Set **Display Background Color** to the desired color.

### Adding a Custom Background Image

You can add or remove custom background images only from the web administration interface.

1. Open a browser and enter the system's IP address to log into the web administration interface.
2. Access **Preferences : Appearance : Backgrounds**.
3. Click **Add** and browse to the image file. Images must be 1280 x 720 JPGs with unique display names.
4. To apply the new image, select it and click the desired display.

### Choosing a Background Color from the Interface

You can choose a custom background color only from the web administration interface.

1. Open a browser and enter the system's IP address to log into the web administration interface.
2. Access **Preferences : Appearance : Backgrounds**.

3. Click the color swatch next to the current background for the display.
4. Use the eye dropper  to choose a color from the web administration interface.
5. Click the display to apply the color.

### Defining a Custom Color

You can define a custom color only from the web administration interface.

1. Open a browser and enter the system's IP address to log into the web administration interface.
2. Access **Preferences : Appearance : Backgrounds**.
3. Click the color wheel  to access the color editor.
4. Specify a custom color by supplying RGB values or a hexadecimal value; or choose a predefined color by clicking a color swatch from the color editor.
5. Click **Save Changes**.
6. Click the display to apply the color.

## Configuring Call Preferences

All users can set auto answer options for calls and specify the maximum number of entries to appear in the **REDIAL** list. Read more at [Automatically Answering Calls](#) and [Managing the REDIAL List](#).

Administrators configure additional call preferences in **Administrator Preferences : Calls**.

## Managing Bandwidth

Specify the maximum bandwidth that an outgoing or incoming call uses by setting **Outgoing Call Bandwidth** or **Incoming Call Bandwidth** in **Administrator Preferences : Calls**. The value for **Outgoing Call Bandwidth** becomes the maximum value that users can choose from the dropdown menu when manually placing a call from the main page or when specifying a bandwidth in a directory entry.

If a user specifies *Auto* for the bandwidth when placing a call, the outgoing bandwidth becomes the starting point for negotiating bandwidth when the call connects. In addition, the system uses the appropriate bandwidth based on the following:

- display resolution and frame rate of the device: 1080p30 or 720p60
- capability of the input device

**Outgoing Total Bandwidth** and **Incoming Total Bandwidth** set the maximum amount of network bandwidth to use for all outgoing and incoming calls.

**Auto Bandwidth** addresses how the system responds to packet loss during a call. When set to the default of *Enabled*, the system attempts to use the best available bandwidth after the call connects.

## Selecting a Maximum Call Time

Control the amount of time that a call stays connected at **Administrator Preferences : Calls : Maximum Call Time**. When this preference is set and the time expires, the call stops without an option to extend.

## Admission Control

Admission control rejects calls to multiway capable systems under a heavy call load. Enable or disable this preference in **Administrator Preferences : Calls : Admission Control**.

## Hiding the Dominant Speaker Icon

The dominant speaker icon  indicates which participant is speaking. Hide the icon by disabling **Administrator Preferences : Calls : Dominant Speaker Icon**.

# Configuring Communications Preferences

Specify protocols the system uses during calls in **Administrator Preferences : Communications**.

## Disabling Multiway Calling

Disable multiway calling on LifeSize systems by setting **Administrator Preferences : Communications : General : Multiway Calls** to *Disabled*. You can configure this preference only when the system is not in a call. Choosing *Disabled* allows only one call, voice or video, to connect to the system.

If the system includes an embedded multipoint bridge, the *One Video + One Voice* option also appears for this preference. This option allows the system to connect to a video and a voice call as the maximum number of connected callers.

## Configuring Dialing Options

Choose video and voice dialing options during initial configuration or in **Administrator Preferences : Communications : General**.

Dialing Option	System	Preference	Default Value
Video	LifeSize Room 220 LifeSize Team 220 LifeSize Express 220	<ul style="list-style-type: none"> <li>Auto (enables the system to determine the best method to use to place calls)</li> <li>IP</li> <li>ISDN</li> </ul>	Auto
Voice	LifeSize Room 220 LifeSize Team 220	<ul style="list-style-type: none"> <li>VoIP (uses H.323 or SIP)</li> <li>H.323</li> <li>SIP</li> <li>ISDN</li> <li>Touch Tone (uses PSTN)</li> </ul> <p>When you place a call with the <b>voice</b> button on the LifeSize phone connected to the system and voice dialing is set to touch tone, you can dial phone numbers using only PSTN connectivity. When voice dialing is set to VoIP, you can dial IP addresses and phone numbers.</p>	VoIP
	LifeSize Express 220	<ul style="list-style-type: none"> <li>VoIP</li> <li>H.323</li> <li>SIP</li> <li>ISDN</li> </ul> <p>When you place a call with the <b>voice</b> button on the LifeSize phone connected to the system, you can dial IP addresses; and VoIP or ISDN phone numbers.</p>	VoIP

When you place a call with the remote control or with the **video** button on the phone, you can dial IP addresses (and phone numbers on LifeSize Room 220 and LifeSize Team 220). This enables systems inside a corporate network without access to a gateway to call other LifeSize systems in the network using system IP addresses.



## Disabling PSTN

On LifeSize systems that support PSTN connectivity, you can disable support for placing and receiving PSTN calls by setting **Administrator Preferences : Communications : General : PSTN** to *Disabled*. You can configure this preference only when the system is not in a call.

## Enabling Presentations

By default, the presentation function is enabled on LifeSize systems. Disable presentations in **Administrator Preferences : Communications : General : Presentations**. Consider disabling the presentation function if your system experiences interoperability issues with third party systems that do not support presentations.

---

**NOTE** When presentations are disabled for all participants during a call, the user interface provides the option to send video from the presentation input as the primary video stream. Read more at [Initiating a Presentation](#) and [Changing Video Inputs](#).

---

## Manually Starting a Presentation

By default, a presentation starts automatically during a call if a user connects a video input device other than any LifeSize camera to the codec and the video input device is not selected as the primary input. The user interface switches the presentation input to this video input and starts the presentation. The presentation stops automatically if the video input device is disconnected during the call.

Set **Administrator Preferences : Communications : General : Auto Start Presentation** to *Manual* to allow users to start a presentation manually.

## Supported DVI-I Input Resolutions

LifeSize systems support native 16:9 and 4:3 VGA and DVI-I inputs. The **System Information** page shows the actual DVI-I input size. The input selector shows a 16:9 or 4:3 window for the input depending on the aspect ratio. LifeSize systems support the following resolutions:

- 640 x 480
- 800 x 600
- 1024 x 768
- 1280 x 720
- 1280 x 768
- 1280 x 1024

---

**NOTE** These resolutions are supported only with a screen refresh rate set to 60 Hertz (Hz) on the device connected to the DVI-I input.

---

The resolutions are sent natively to the far end for the primary or secondary video streams. The resolutions may not exactly match because of H.264 or H.263 protocol resolution constraints. Additional factors that may affect the actual resolution include the position of the video quality sliders and available bandwidth on the call. Set the video quality sliders in **Administrator Preferences : Video : Video Quality**.

Following are the supported input resolutions and frame rates for video sent to the DVI-I input from an HDMI source:

- 480p60
- 576p50
- 720p60
- 1080p30

If audio is sent to the DVI-I input from an HDMI source, the audio is sent to the near end speakers and to the far end when the DVI-I input is selected as the primary or presentation video input. Read more at [Configuring HD In and DVI-I In](#).

## Configuring H.323 Settings

By default, LifeSize systems support the H.323 protocol for placing and receiving video and voice calls. Disable support for H.323 calls in **Administrator Preferences : Communications : H.323** when the system is not in a call. When you disable H.323, the system uses only the SIP protocol.



---

**NOTE** If **H.323** and **SIP** are both disabled (and LifeSize Networker is not connected to the system), a warning message indicates that video calls cannot be placed or received with this configuration. Read about SIP preferences at [Configuring SIP Settings](#).

---

Preference	Description	Default Value
<b>H.323</b>	When <b>H.323</b> is enabled, you can specify an H.323 name or extension to use when placing a call. The H.323 name and extension identify the device to the gatekeeper. Any registered device can dial another using this name and extension.	Enabled
<b>H.323 Name</b>	Optional value that is used when a gatekeeper is configured and requires the system to register with an H.323 ID.	Conference Room plus the last 2 bytes of the MAC address
<b>H.323 Extension</b>	Optional value that is used when a gatekeeper is configured and requires the system to register with an E.164 number or extension.	last 2 bytes of the MAC address
<b>Gatekeeper ID</b>	Set only when required by the gatekeeper; for example, for configurations with multiple gatekeepers. The <b>Gatekeeper ID</b> must match the gatekeeper ID configured for the gatekeeper to which the system is registering. Do not configure this preference if the gatekeeper does not require it, as this may result in failure to register with the gatekeeper.	No default
<b>Gatekeeper Mode</b>	Allows you to choose a gatekeeper. Set this preference to <i>Auto</i> if you wish to have the system automatically discover a gatekeeper; set to <i>Manual</i> to manually choose a gatekeeper. If set to <i>Manual</i> , specify the IP address and port for the primary gatekeeper.	Disabled

Preference	Description	Default Value
<b>H.323 Tunneling</b>	Optional value that instructs the system to send all signaling and media through the HTTP tunnel.	Disabled
<b>H.460</b>	Specifies firewall traversal of H.323 calls using H.460 protocols. Read more at <a href="#">Enabling H.460 Support for H.323 Calls</a> .	Disabled
<b>Gatekeeper IP Address 2 and Gatekeeper Port 2</b>	Allows you to configure a secondary H.323 gatekeeper.	No defaults
<b>Gatekeeper Authentication</b>	Allows you to specify a username and password for the gatekeeper.	Disabled

When you select **Register** in **Administrator Preferences : Communications : H.323**, icons in the status bar indicate the status of the registration process with the H.323 gatekeeper. The yellow H.323 icon  appears when your LifeSize system is trying to register with the gatekeeper. If the registration fails, the red H.323 icon  appears. If the system is registered to a gatekeeper, the system reports its status.

## Enabling H.460 Support for H.323 Calls

LifeSize systems support firewall traversal of H.323 calls using H.460 protocols. You must have an H.460 server configured in your environment for this feature to function properly.

---

**NOTE** If you configure H.323 settings and enable H.460 support, the system ignores preferences in **Administrator Preferences : Network : NAT**.

---

To enable H.460 client support on a LifeSize system, configure the H.323 preferences in **Administrator Preferences : Communications : H.323** as described in [Configuring H.323 Settings](#) with the following exceptions:

1. Choose *Manual* for the **Gatekeeper Mode**.
2. For **Gatekeeper IP Address 1** and **Gatekeeper Port 1**, enter the IP address and port number of the H.460 server that is configured in your environment.
3. Choose *Enabled* for **H.460**.
4. Navigate to **Register** and press **OK**.

---

**NOTE** If you enable H.460 and specify the IP address and port number of a secondary gatekeeper with **Gatekeeper IP Address 2** and **Gatekeeper Port 2**, the system ignores the secondary gatekeeper.

---

## Configuring SIP Settings

By default, LifeSize systems support Session Initiation Protocol (SIP). Disable support for SIP calls in **Administrator Preferences : Communications : SIP** when the system is not in a call. When you disable SIP, the system uses only the H.323 protocol.



---

**NOTE** If **SIP** and **H.323** are both disabled (and LifeSize Networker is not connected to the system), a warning message indicates that video calls cannot be placed or received with this configuration. Read about H.323 preferences at [Configuring H.323 Settings](#).

---

Preference	Description	Default Value
<b>SIP</b>	When enabled, allows you to specify a SIP name to use when placing a call.	Enabled
<b>SIP Username</b>	SIP username for the device.	LifeSize
<b>Authorization Name</b>	SIP server authorization username. Set a value only if required by the registrar or proxy.	No default
<b>Authorization Password</b>	SIP server authorization password. Set a value only if required by the registrar or proxy.	No default
<b>SIP Server Type</b>	Type of SIP registrar and proxy servers. If you plan to use Microsoft Office Communications Server 2007 or Microsoft Lync Server for SIP calls with your LifeSize system, choose <i>Microsoft OCS</i> . Refer to the release notes for information about supported Microsoft Office Communications Server 2007 and Microsoft Lync Server versions. Refer to the LifeSize technical note <i>Using LifeSize Systems with Microsoft Office Communications Server and Microsoft Lync Server</i> for configuration information.	Auto
<b>SIP Registration</b>	Communication path to use when registering with a SIP registrar. SIP devices use register settings to dynamically register their current location.	Through Proxy
<b>SIP Proxy</b>	When enabled, uses a SIP proxy server.	Disabled
<b>Proxy Hostname</b>	Hostname or IP address of the SIP proxy server.	No default
<b>SIP Registrar</b>	When enabled, uses a SIP registrar server.	Disabled
<b>Registrar Hostname</b>	Hostname or IP address of the SIP registrar server.	No default
<b>Internal Server</b>	Hostname or IP address of the Microsoft OCS internal server.	No default
<b>External Server</b>	Hostname or IP address of the Microsoft OCS external server.	No default
<b>SIP Signaling</b>	Preferred SIP signaling protocol. To specify the signaling protocol, a SIP registrar must be enabled. Signaling protocols are mutually exclusive; that is, enabling one disables the others. Disabling the SIP registrar automatically sets the signaling protocol to <i>Auto</i> .	Auto
<b>UDP Signaling Port</b>	UDP port number of the SIP configuration.	5060

Preference	Description	Default Value
<b>TCP Signaling Port</b>	TCP port number of the SIP configuration.	5060
<b>TLS Signaling Port</b>	TLS port number of the SIP configuration. If you enable TLS signaling, the system attempts to use Secure Real-time Transport Protocol (SRTP) for media encryption in SIP calls. If the far side supports SRTP, the media is encrypted and encryption icons appear in the caller ID, Call Manager list, and Call Statistics list during a call. Read more at <a href="#">Call Encryption</a> . If the far end does not support SRTP, the media is not encrypted and call encryption icons do not appear in the user interface.	5061

When you select **Register** and press **OK**, icons in the status bar indicate the status of the registration process with the SIP server. The yellow SIP icon  appears when your LifeSize system is trying to register with the SIP server. If the registration fails, the red SIP icon  appears.

---



**NOTE** The system reboots if you change the signaling port; or enable or disable signaling.

---

# Configuring Audio Behaviors

Adjust audio behaviors in **Administrator Preferences : Audio** by [Configuring Audio Input](#), [Selecting Audio Output](#), and [Adjusting Audio Volume](#).

Additional audio settings include:

<b>Microphone status</b>	<p>The <b>Active Microphone</b> field on the <b>System Information</b> page shows which device is functioning as the active microphone. When the value is <i>None</i>,  appears in the status bar of the user interface.</p> <p>NOTE: If you choose a line in option as the active microphone and a device is not connected to line in on the codec,  does not appear in the user interface and the <b>System Information</b> page shows line in as the status for <b>Active Microphone</b>.</p> <p>The <b>Microphone In</b> field appears on the <b>System Information</b> page for systems that have a microphone in connector on the codec and indicates the connection status of a device for the input: <i>None</i>, <i>Ready</i>, or <i>Error</i>.</p>
<b>Muting audio inputs</b>	<p>When you press the mute button on the remote control or on a LifeSize audio input device, all audio inputs to the system are muted by default, including audio from the active microphone, a PC connected to the codec for a presentation, or a device connected to auxiliary inputs if available on the codec. To configure the system to mute only the active microphone, select <i>Active Microphone Only</i> for <b>Audio Mute</b> in <b>Administrator Preferences : Audio</b>. The default is <i>All Inputs</i>. The <b>Audio Mute</b> field on the <b>System Information</b> page shows the setting for this preference.</p>
<b>Testing primary audio output</b>	<p>Test audio output to speakers connected to the codec as the primary audio output device during initial configuration or in <b>Administrator Preferences : Audio : Primary Audio Output Test</b>. Select a channel to test, or select <i>Auto</i>. The <i>Auto</i> option cycles through available channels and plays the test tone for 5 seconds before moving to the next available channel. To end the test, choose <i>Off</i>. Send the tone to the left or right channel by choosing <i>Test Left</i> or <i>Test Right</i>. The tone is sent simultaneously to both line out and HD video out of Display 1.</p>
<b>Configuring audio codec order</b>	<p>Change the order of audio codecs the system uses when placing calls in <b>Administrator Preferences : Audio : Audio Codec Order</b>.</p>

## Configuring Audio Input

### Configuring Audio In (Line In)

LifeSize systems automatically send audio from a device connected to line in on the codec to line out, except when line in is selected for **Active Microphone**. Line in is mono when selected as the **Active Microphone**.

*LifeSize Room 220 and LifeSize Team 220 only.* Set **Administrator Preferences : Audio : Line In 1 Association** and **Line In 2 Association** to associate video input with these inputs. If you choose *Any Input*, the device attached to the line input is always audible. If you choose a specific video input, the device attached to the line input is audible only when the video image from the selected video input appears in the display. If you select line in as the active microphone, its associated video input is automatically set to *Any Input* and you must use **Active Microphone Volume** to adjust the volume for the line input.

Set the volume of line in at **Administrator Preferences : Audio : Line In Volume**.

## Selecting the Active Microphone

LifeSize systems can connect to more than one microphone device for audio input during calls; for example, your LifeSize phone, LifeSize Focus, and on codecs with a microphone in connector, LifeSize MicPod. Only one of these devices can function as the active microphone during a call.

Select a device to serve as the active microphone during initial configuration or in **Administrator Preferences : Audio : Active Microphone**. Options that are available for **Active Microphone** depend on the LifeSize system model:

Model	Active Microphone Options
All models	Auto (default) Phone Microphone In Microphone In (no AEC)
LifeSize Express 220	Line In Line In (no AEC)
LifeSize Room 220 LifeSize Team 220	Line In 1 Line In 1 (no AEC) Line In 2 Line In 2 (no AEC) Camera 1

Use the *Microphone In (no AEC)* and *Line In (no AEC)* options to connect microphones that have their own acoustic echo canceller.

To use a device connected to line in on the codec as the active microphone, choose the corresponding line in option manually for **Active Microphone**.

Use Camera 1 to specify LifeSize Focus as the active microphone.

When **Active Microphone** is set to *Auto*, or if the option selected is not connected to the codec, the system automatically attempts to select a device in the following order:

1. Phone
2. Microphone In
3. *LifeSize Room 220 and LifeSize Team 220 Only*: Camera 1

When **Active Microphone** is set to *Auto*, the following conditions apply:

- A LifeSize system ignores audio input from a LifeSize MicPod connected to the microphone input if the LifeSize phone is also connected to the system. The LifeSize phone becomes the active microphone and the LEDs on the LifeSize MicPod flash red to indicate an invalid configuration. To stop the LEDs from flashing red, disconnect the LifeSize MicPod or enable audio input from the LifeSize MicPod by setting **Administrator Preferences : Audio : Active Microphone** to *Microphone In*.
- The system does not automatically choose Line In.

## Selecting Audio Output

Select audio output during initial configuration or in **Administrator Preferences : Audio**.

By default, audio in a video call is sent to your display (*HD Out*). If you wish audio in a video call to be sent to the attached phone, set **Video Call Audio Output** to *Phone*.

By default, audio in a voice call is sent to the LifeSize phone attached to the LifeSize codec. If you want the audio in a voice call to be sent to the line out or your display, set **Voice Call Audio Output** to *Line Out* or *HD Out*. If the LifeSize phone is not connected to the LifeSize codec, audio in a voice call is sent to the line out regardless of the preference selected.

## Adjusting Audio Volume

### Adjusting the Active Microphone Volume

Adjust the audio level for the active microphone at initial configuration or in **Administrator Preferences : Audio : Active Microphone Volume**.

A built-in acoustic echo canceller and noise reducer are active when one of the following is the active microphone:

- *Microphone In*
- *Camera 1* on LifeSize Room 220 or LifeSize Team 220
- *Line In*

The built-in acoustic echo canceller automatically attempts to adjust audio volume for optimum levels.

An audio meter appears below **Active Microphone Volume**. The audio meter follows the digital signal processing, Automatic Gain Control (AGC), and volume and tone controls on the transmitted voice path as depicted in the following illustration.

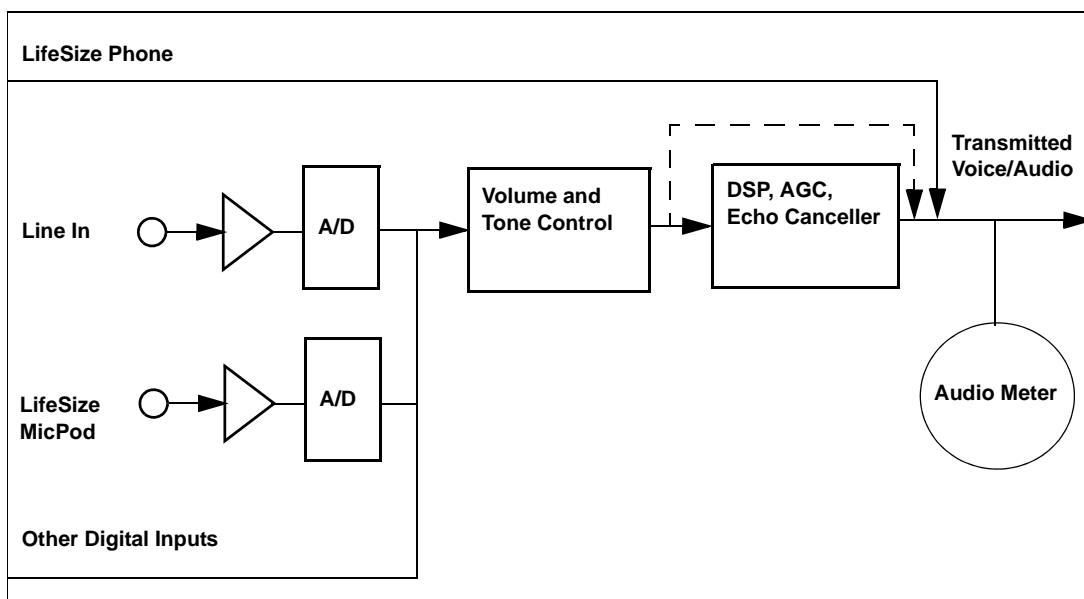



The dotted line illustrates the audio path when *Microphone In (No AEC)* or *Line In (No AEC)* is selected as the active microphone. These values are useful for setting up system gains, but should never be used during calls unless the installation includes audio inputs with external AEC. Echo may occur if no AEC is employed.

If you choose the LifeSize phone as the active microphone, **Active Microphone Volume** is not available. The LifeSize phone microphones adjust volume automatically. The voice stream bypasses all processing in the LifeSize system, including the volume and tone controls, and is fed directly into the transmitted voice path.

The audio meter shows the level of the transmitted voice in decibels (dB) root mean square (RMS) below digital full scale (DFS). The meter is accurate to  $\pm 1$  dB. The maximum level is 0 dB. Levels below  $-50$  dB do not appear and indicate a very quiet or inactive input. Typical levels during a call peak around  $-28$  to  $-22$  dB DFS. The AEC and AGC attempt to keep the RMS transmit level below  $-20$  dB DFS. The following images show what appears in an audio meter at various levels.

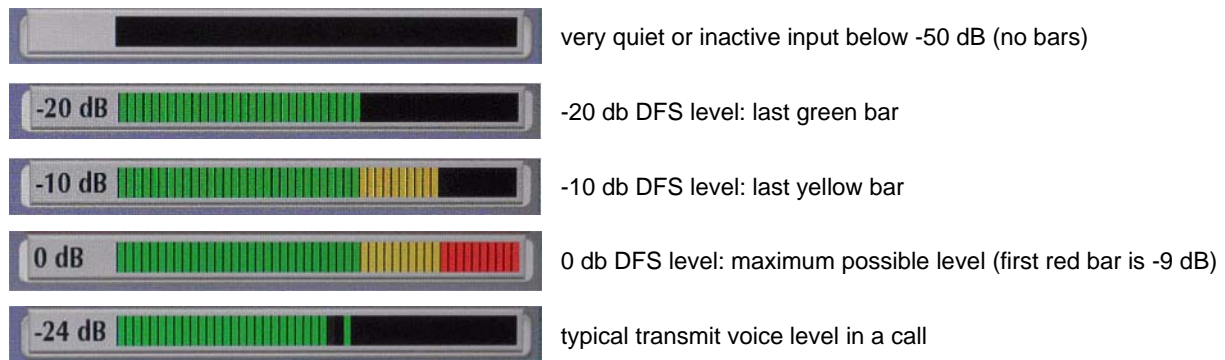

*LifeSize Room 220 and LifeSize Team 220 Only:* When setting **Active Microphone Volume** for LifeSize MicPod or LifeSize Focus, place someone in a common place for a call and ask them to speak at a normal volume facing the active microphone. Use the audio meter to visually verify that the transmit level peaks in the desired  $-28$  to  $-22$  dB range.

LifeSize recommends a volume setting of 5 to 8 for **Active Microphone Volume** for most LifeSize MicPod applications.

*LifeSize Room 220 and LifeSize Team 220 Only:* LifeSize recommends a volume setting of 5 to 10 for **Active Microphone Volume** for most LifeSize Focus applications.

If you set **Active Microphone Volume** to a line in option when using an external mixer or amplified microphone, follow these steps:

1. Select *Line in 1 (no AEC)* for **Active Microphone**.
2. Position someone approximately one meter from the microphone, facing it, speaking at a normal volume.
3. Adjust the **Active Microphone Volume** and the external mixer output level until the meter peaks in the  $-28$  to  $-22$  dB range. Adjust the external mixer volume so that you achieve peak levels in the  $-28$  to  $-22$  dB range of the audio meter with the **Active Microphone Volume** control no less than 5 or greater than 15.

4. If the microphone or mixer uses an echo canceller, no further adjustments are necessary; otherwise, select *Line In* for **Active Microphone**. This turns on the LifeSize system's echo canceller, noise reduction, and automatic gain control functions. If you do not use an echo canceller, you may experience severe echo effects.
5. After the adjustment, check that the peak levels when speaking normally one meter from the microphone are in the -28 to -22 dB range. The AGC attempts to keep the transmit level below -20 dB, which is the green range of the bar graph.

An audio meter is also available for the **Line In Volume** preferences for setting an audio level for a device connected to these inputs on the codec when the line in is not selected as the active microphone.

## Adjusting Audio Levels

<b>Line Out Treble</b> (dB)	Adjust the higher frequencies in the sound range for the audio line output.
<b>Line Out Bass</b> (dB)	Adjust the lower frequencies in the sound range for the audio line output.
<b>Ring Tone Volume</b>	Select the volume level of the ring and busy tones.
<b>DTMF Tone Volume</b>	Select the volume level of the DTMF and key click tones.
<b>Status Tone Volume</b>	Select the volume level of status tones.

# Configuring Video Behaviors

Administrators control cameras and video quality in **Administrator Preferences : Video**.

## Controlling Camera Use by Far End Users

To prevent far end users from controlling your near end camera, including configuring and controlling camera presets, disable **Administrator Preferences : Video : Video Control : Far Control of Near Camera**. If you choose *Enabled*, you can still prevent far end users from configuring and using near end camera presets by disabling **Far Set of Camera Presets** and **Far Move to Camera Presets**.

## Controlling Camera Pan Direction

Define the camera's pan direction relative to the physical arrangement of the camera in **Administrator Preferences : Video : Video Control : Camera Pan Direction**. Select *Perceived* for the camera to pan left or right from the user's perspective when facing the camera. Select *Reversed* for the camera to pan to the camera's actual left or right.

## Specifying Primary and Presentation Input Defaults

Specify defaults for the primary and presentation inputs in **Administrator Preferences : Video : Video Control**. Users can change the inputs before or during a call. The system resets to the defaults when the call terminates to ensure that the default input is always selected when a call starts. If you choose *Manual* for these preferences, the user interface shows the last selected input and does not automatically change the inputs.

If you choose *Auto* for **Default Presentation Input**, the system chooses the device connected to the VGA or DVI-I input on the codec.

If you choose *Auto* for **Default Primary Input**, the system chooses a default input device in the following order:

LifeSize Model	Input Priority
LifeSize Express 220	HD Input 1
LifeSize Room 220 LifeSize Team 220	<ol style="list-style-type: none"> <li>1. HD Input 1, if connected to any LifeSize PTZ camera</li> <li>2. <i>LifeSize Room 220 only</i>: HD Input 2, if connected to any LifeSize PTZ camera</li> <li>3. HD Camera 1, if LifeSize Focus is connected to the port labeled <b>System Camera Only</b></li> <li>4. <i>Sony cameras only</i>: Component input. Refer to the technical note <i>Using Sony Cameras with LifeSize Video Communications Systems</i>.</li> <li>5. HD Input 1, if connected to a device other than any LifeSize PTZ camera</li> </ol>

## Configuring HD In and DVI-I In

If your LifeSize system has one or more HD inputs or a DVI-I input on the codec, you may need to adjust the **HD Input Type** and **DVI-I Input Type** preferences in **Administrator Preferences : Video : Video Control**. The default option *Auto* works with most devices. If no video image or a solid colored image appears from the HD device attached to the HD input on the codec, choose the *DVI* option for this preference. Choosing the *DVI* option forces the LifeSize system to use only DVI video and ignore any audio input. Instead, connect the audio from the attached HD device to the line in port on the back of the codec.

## Balancing Primary and Presentation Video Bandwidth

For video images sent to the far side during a presentation, you can allocate bandwidth to the primary and presentation video input streams as percentages of the total available bit rate for the video streams. Select the percentage in **Administrator Preferences : Video : Video Quality : Video Bandwidth Balance**.

---

**NOTE** Adjust this preference before placing a call. Adjusting this preference during a call has no effect.

---

The first percentage in each option applies to the primary video input stream, typically the high definition camera. The second percentage applies to the presentation video input stream, typically a laptop connected to the codec. The system allocates the bandwidth based on the selected option only when the system sends video images during a presentation. Consider allotting a larger percentage to the presentation video input stream when the presentation video input includes motion. Examples include a slide show that includes several animations or video input from a DVD player.

## Adaptive Motion Control

Adaptive motion control minimizes video problems caused by minor packet loss and improves video reproduction. For packet loss of 5% or less, this feature eliminates or greatly reduces video artifacts. This feature is enabled by default in **Administrator Preferences : Video : Video Quality : Adaptive Motion Control**.

## Controlling Digital Zoom

Digital zoom electronically crops an area of the video image that appears in the display using the same aspect ratio as the original image and then scales the cropped image to the dimensions of the original image. Digital zoom is available with your LifeSize camera connected to LifeSize Room 220 or LifeSize Team 220 through firewire.

---

**NOTE** Image quality may degrade when using digital zoom.

---

By default, digital zoom is disabled. Enable this feature by enabling **Administrator Preferences : Video : Video Control : Digital Zoom**. Read more at [Using Digital Zoom](#).

## Saving Video Snapshots

Save video snapshots in JPG format from the near and far cameras from the **Call Manager** in the web administration interface. Click **Save Snapshot**  to capture a video image from the near or far camera.

If the web administration interface shows the **Call Manager**, the system awakens and does not go to sleep. If you navigate away from the **Call Manager** screen, or the web administration interface times out to the login screen, the system goes to sleep after the interval specified by **Screen Saver Timeout** plus **Sleep Timeout**.

By default, video snapshots are enabled. Disable video snapshots from the web administration interface in **Preferences : Video : Video Control : Video Snapshot**; or from the video system in **Administrator Preferences : Video : Video Control : Video Snapshot**. You can also use the  button in the **Call Manager** in the web administration interface to disable or enable video snapshots.

---

**NOTE** Video snapshots are not available if **Recorder** is enabled in **Administrator Preferences : Video : Record and Stream**.

---

## Customizing Input Device Names

Define custom input names in **Administrator Preferences : Video : Video Control**. Customized names for inputs are limited to 16 characters.

Preference	System	Default Value
HD Camera 1 Name	LifeSize Room 220 LifeSize Team 220	HD Camera 1
HD Input 1 Name	LifeSize Express 220 LifeSize Room 220 LifeSize Team 220	HD 1
HD Input 2 Name	LifeSize Room 220	HD 2
Auxiliary Video Input Name	LifeSize Room 220	DVD
DVI-I Input Name	LifeSize Express 220 LifeSize Room 220 LifeSize Team 220	PC

## Controlling Video Stretch

Stretch PC input or presentations to fill their portion of the screen by enabling **Stretch Video** in **Administrator Preferences : Video : Video Control**. Typically, 4:3 aspect ratio stretches to 16:9. The default is *Disabled*.

---

**NOTE** Enabling this preference has no effect if the resolution of either display connected to the system is 1920x1080.

---

The **System Information** screen shows the actual input size for the **DVI-I Input** status. The input selector shows a 16:9 or 4:3 window for the input depending on the aspect ratio.

## Choosing a VISCA Input with Supported Third Party Cameras

Select the input on the codec to which a VISCA controlled camera is connected in **Administrator Preferences : System : Serial Ports**.

Port	Preference	Description
<b>RS-232</b>	<b>RS-232 Port 1 Shell</b>	<i>LifeSize Room 220 Only:</i> Choose <i>VISCA</i> to configure VISCA camera control through the RS-232 port on the codec.
	<b>RS-232 Port 1 VISCA Input</b>	<i>LifeSize Room 220 Only:</i> Select the video input to control with VISCA.
<b>USB Serial</b>	<b>USB Serial Shell</b>	Choose <i>VISCA</i> to configure VISCA camera control through the serial USB port on the codec.
	<b>USB Serial VISCA Input</b>	Select the video input to control with VISCA.

Read more in the technical note *Using Sony Cameras with LifeSize Video Communications Systems*.

## Selecting Priority of Quality Metrics for Source Video

You can favor sharpness or motion for the quality of primary and presentation video that the LifeSize system sends to the far end during a call. If you favor sharpness by selecting a smaller number in **Administrator Preferences : Video : Video Quality : Primary Video Motion**, in lower bandwidth calls the system sends the primary video at a lower frame rate and a higher resolution. The default value (10) favors motion. Consider adjusting this preference if bandwidth is limited.

If you are sending a presentation, select the priority for the quality of the presentation video in **Administrator Preferences : Video : Video Quality : Presentation Video Sharpness**. The default value (10) favors sharpness. Typically, presentation data that includes a spread sheet or slide show does not include motion. When you favor motion for presentation video by selecting a smaller number for this preference, the system sends the video at a higher frame rate and a lower resolution.

## Adjusting Video Encoder Quality

Adjust the quality of the video image sent to the far end during a call by specifying a relative lower or higher resolution in **Administrator Preferences : Video : Video Quality : Video Encoder Quality**. Moving the slider to the right improves the quality of the video image.

## Adjusting the MTU of Video Packets

Video packets that exceed the maximum transmission unit (MTU) size for any router or segment along the network path may be fragmented or dropped. This results in poor quality video at the receiving device. Set the MTU of video packets that your LifeSize system sends in **Administrator Preferences : Video : Video Quality : Video MTU**. The default value is 1440 bytes. The allowed range is 900 -1500 bytes. Refer to the technical note *Troubleshooting Packet Loss* for steps you may take to address packet loss.

## Configuring LifeSize Video Communications Systems to Record

With LifeSize Video Center in your environment, LifeSize video systems can initiate a recording to LifeSize Video Center. By default, the recording capability is disabled. To enable recording, complete these steps:

1. On the LifeSize video communications system, navigate to **Administrator Preferences : Video : Record and Stream**.
2. Set **Recorder** to *Enabled*.
3. In **Recorder Hostname**, enter the IP or DNS address of the recording and streaming server. In most cases, you can accept the default of **Recorder Port** set to 443.

---

**NOTE** If your network uses NAT with port forwarding rules that remap port 443 between the video communications system and the server, **Recorder Port** must reflect the remapped port number.

---

4. To provide a default key to use for server authorization for all recordings from this system, enter it in **Recording Key**. If you leave this setting blank, the system prompts users to enter a key for each recording.
5. To record all calls, set **Auto Record** to *Enabled*.
6. In **Default Recording Layout**, choose to record *All Callers*, *Near Video Only*, or *Far Video Only*.

---

**NOTE** A layout specified through the recording key on LifeSize Video Center overrides the **Default Recording Layout** set at the video system.

---

# Security Preferences

Enable FIPS 140-2 and H.235 AES security in **Administrator Preferences : Security**.

## Enabling FIPS 140-2 Security

LifeSize video communications systems support the Federal Information Processing Standard (FIPS) 140-2, (Level 1), a U.S. government computer security standard. By default, FIPS security is disabled. When you set **FIPS 140-2** to *Enabled* in **Administrator Preferences : Security : General**, the following occurs:

- **HTTP, Telnet, and SNMP** in **Administrator Preferences : Security : General** are automatically set to *Disabled* and unavailable for configuration.
- Login access to the command line interface through SSH is disabled.

---

**NOTE** The current value for the **SSH** preference does not change.

---

- **802.1x Authentication** in **Administrator Preferences : Network : General** is automatically set to *Disabled* and unavailable for configuration.
- The **License Keys** button on the **Administrator Preferences : System** screen is unavailable.
- **H.235 AES Security** in **Administrator Preferences : Security : General** is automatically set to *Enabled*, if not already set to *Enabled* or *Strict*.
- **SIP Signaling** in **Administrator Preferences : Communications : SIP** is set to *Auto*.
- The system reboots after you exit the **Administrator Preferences : Security : General** screen.
- A red  icon appears in the status bar on the main page until the system completes the configuration changes to enable FIPS security.
- *FIPS 140-2 Security Enabled* appears above the **Security** button on the **Administrator Preferences** screen after the system reboots.

When **FIPS 140-2** is set to *Enabled*, you cannot upgrade the system software; you must first set **FIPS 140-2** to *Disabled*. Ensure that **HTTP** and **SSH** are set to *Enabled* before attempting to perform an upgrade.

If you change the **FIPS 140-2** preference from *Enabled* to *Disabled*, the following occurs:

- Preferences that were unavailable for configuration as a result of enabling this preference become available.
- Login access to the command line interface through SSH is enabled.

---

**NOTE** The current value for the **SSH** preference does not change.

---



- **HTTP** and **SNMP** are set to *Enabled*.

---

**NOTE** Preferences other than **HTTP** and **SNMP** that were modified as a result of setting **FIPS 140-2** to *Enabled* do not change.

---

- The system reboots after you exit the **Administrator Preferences : Security : General** page.

## Enabling H.235 AES Security

LifeSize systems support H.235 128-bit AES security in H.323 calls. AES interoperability is supported with the third party devices identified in the release notes.

To enable AES security, you must set **Administrator Preferences : Security : General : H.235 AES Security** to *Enabled* or *Strict*. When set to *Enabled*, calls connect, but are encrypted only if the far end supports AES encryption. When set to *Strict*, calls do not connect if the far end does not support AES security. To ensure that all call connections are encrypted when the LifeSize system is serving as the MCU in a call, set this preference to *Strict*.

Encrypted calls are indicated by encryption icons in the caller ID, Call Manager list, and Call Statistics list. Read more at [Call Encryption](#).

## Directories

Your LifeSize system includes three directories: local, corporate, and meetings. Users can place calls from all directories; and add entries to the local and meetings directories. Read more at [Working with Directories](#).

### Disabling Access to the Local Directory

By default, users can add, remove, or modify entries; and place calls from the local directory.

Disable user access to the local directory by setting **Local Directory** to *Disabled* in **Administrator Preferences : Directory : General**. Disabling access to the local directory also disables the following:

- Saving entries from the **REDIAL** list to the local directory.
- Copying corporate directory entries to the local directory.
- Selecting entries from the local directory when creating an entry in the meetings directory.

Even if access is disabled from the user interface, you can access the local directory on the **Directory** page in the web administration interface. Read more at [Managing Directories from the Web Administration Interface](#).

### Populating the Corporate Directory

Users can place calls from the directory by selecting a number to dial from a list of stored numbers. The corporate directory is H.350 compliant and can store up to 1000 entries in alphabetical and hierarchical format. All users can manage entries in the local and meetings directories. Only administrators can manage entries in the corporate directory.

Populate the corporate directory by configuring **Auto Discovery** preferences or Lightweight Directory Access Protocol (LDAP) preferences in **Administrator Preferences : Directory**. By default, auto discovery is enabled and LDAP is disabled. You can enable only one of these methods. The system automatically disables the other method to prevent duplicate entries from appearing in the corporate directory. The status, enabled or disabled, appears in **Administrator Preferences : Directory**. The connection status of the LDAP installation also appears on this page and on the **System Information** page. Connection status can appear as one of the following values:

LDAP Connection Status	Description
Unregistered	LDAP preferences are not configured.
Registered	LDAP preferences are configured. The last attempt by the LifeSize system to contact the LDAP server and receive data was successful.
Unreachable	LDAP preferences are configured, but the LDAP hostname is invalid or the service does not exist.
Unauthorized	LDAP preferences are configured, but the username or password is invalid.
Invalid Syntax	LDAP preferences are configured, but the base Distinguished Name (DN) is invalid.
Failed	LDAP preferences are configured, but an unexpected failure occurred.

## Configuring Auto Discovery

Auto discovery enables LifeSize systems on your network to pass address information to other LifeSize systems automatically. When a LifeSize system joins a network, by default it sends a broadcast packet to the local subnet to announce its presence. Any LifeSize system on the local subnet that receives the packet and has **Auto Discovery** set to *Enabled* replies by sending address information about itself and a list of IP addresses of other LifeSize systems that it discovered.

The LifeSize system creates an entry in its corporate directory for every system on the local subnet from which it received a response. It then queries the list of other IP addresses that it received and the IP addresses that are stored in its own Redial list, but only if those addresses are allowed by the filters that you specify in **Auto Discovery Subnets** and **Auto Discovery Ignored Subnets**. By default, the system replies and sends queries to other LifeSize systems in the local subnet only.

Configure **Auto Discovery Subnets** and **Auto Discovery Ignored Subnets** to enable the system to discover other LifeSize systems outside the local subnet and share that information with other LifeSize systems. Specify subnet filters, separated by spaces, in **Auto Discovery Subnets** to identify the subnets where the LifeSize system can send queries and replies. By default, the preference is empty and the system sends queries and replies to other LifeSize systems on the local subnet only.

To exclude subnets from auto discovery, specify subnet filters in **Auto Discovery Ignored Subnets**. If a destination address does not match one of the filters in **Auto Discovery Subnets**, or if it matches one of the filters in **Auto Discovery Ignored Subnets**, the LifeSize system does not query or reply to the LifeSize system at that address.

For example, configure **Auto Discovery Subnets** to include a large subnet and **Auto Discovery Ignored Subnets** to exclude a subset of the subnet. Consider a network that has several subnets with the IP address 10.\* and a slow network connection to devices that have a 10.85.\* address. If you enter 10.\* in **Auto Discovery Subnets** and 10.85.\* in **Auto Discovery Ignored Subnets**, the LifeSize system queries and replies to all LifeSize systems that have a 10.\* address, except those that have a 10.85.\* address.

If you set **Auto Discovery** to *Disabled*, the LifeSize system does not send a broadcast message to the local subnet and cannot discover or be discovered by other LifeSize systems.

## Reading from an LDAP Server

When you enable and configure **LDAP** preferences to populate the corporate directory, you specify the hostname, login and query parameters, and the refresh interval for reading data from a preconfigured LDAP server. LifeSize recommends that you use an LDAP server configured with an H.350 compliant schema.

## Managing Directories from the Web Administration Interface

Advanced usage of the directory is available only from the web administration interface. On the **Directory** tab, click the name of the directory you wish to access. **List All** retrieves the current directory data. Use **Search** to locate a specific entry in the directory.

When viewing the local or meetings directory, click **Clear All** to delete all entries; **Import** to add multiple entries; **Export** to export the entries in CSV format; and **Add New** to add a single entry.

When viewing the corporate directory, click **Export** to export the entries in CSV format.

---

**NOTE** When importing and exporting directory entries from the web administration interface, use a text editor that supports UTF-8 encoding to view or edit the data. Double-byte characters are not supported in directory entries imported using the web administration interface.

---



## Locking the Interface

To lock the interface and cameras, set **Administrator Preferences : Telepresence : Telepresence** to *Enabled*.

During a call, the user interface behaves as follows:

- Video from the call and the mute indicators appear.
- The navigation bar, PIP windows, caller ID information, and call status messages do not appear.

Users interact with the system using an attached phone. Additionally, during a call, users can do the following:

- Press **OK** on the remote control to show the **Call Manager**.
- Press  to show call statistics.
- Press  to change the layout.
- Press  to choose video inputs.
- Use the numeric keys on the remote control play touch tones. Change this behavior from the **Call Manager**.

---

**NOTE** To hide all user interface items while in a call, enable **Hide User Interface**.

---

When the system is idle, only the background image appears in the display.

To access the locked interface, press **OK** and enter the administrator password.

# Maintaining Your System

## Upgrading System Software

This section describes how to apply software updates to your system. Use the same process to downgrade your system to a previous version. Before performing an upgrade or downgrade, consider saving your configuration. Read more at [Saving and Restoring a System Configuration](#).

---

**NOTE** After performing a downgrade, you must reset the system to factory defaults.

---

Before you upgrade your LifeSize system software, ensure that the system meets the following prerequisites:

- All cameras and LifeSize SDI Adapters that you intend to use with the system are properly connected to the codec. Cameras and LifeSize SDI Adapters not connected to a LifeSize system before an upgrade may not function properly after an upgrade.
- If you are upgrading from a release earlier than version 4.0.0, you must first upgrade to version 4.0.0.
- If you are upgrading from software release version 4.0.0 to a later version, a current license key must exist on the system. The expiration date for the upgrade license appears on the **System Information** page. Read more at [Updating License Keys](#).

An upgrade fails if a current license key does not exist on the system. Contact your LifeSize Partner to renew your maintenance agreement. The renewal process may require 24 to 48 hours to complete.

---

**NOTE** Audio levels for the active microphone volume and line in volume preferences were recalibrated in version 4.1.1. If you are upgrading from a previous release, LifeSize recommends that you check these levels after performing the upgrade.

---

To upgrade the software for your system, follow these steps:

1. From [lifesize.com/support](https://lifesize.com/support) click **Download Software**.

---

**NOTE** Access updates directly at [lifesize.com/support/software\\_updates.aspx](https://lifesize.com/support/software_updates.aspx).

---

2. Enter your serial number, which is located on the bottom or back of your LifeSize system codec and on the **System Information** page.
3. Click the link for the software version you wish to download.
4. Download the upgrade to a local directory on your system.
5. Access the web administration interface by entering the IP address of your system in a supported web browser and logging in.

6. Click the **Maintenance** tab.
7. Click **System Upgrade**.
8. If your upgrade requires you to reset the system to the original default settings, select **Reset to Default State**.
9. Browse for the upgrade file you downloaded in step 4.
10. Click **Upgrade**.

---

**NOTE** If calls are connected to the system, a dialog box prompts you to continue or cancel the upgrade. Click **Yes** to continue with the upgrade and disconnect the active calls.

---

The upgrade may take several minutes. Do not disrupt the upgrade process. During an upgrade, a status screen appears; users cannot cancel the screen; and the system rejects incoming calls.

11. A system upgrade status message appears when the upgrade is complete. Close the status and the administrator configuration windows.
12. If you selected **Reset to Default State** in step 8, you must reconfigure your system. Read more at [Initial Configuration](#).
13. To access all web administration options after an upgrade (or downgrade), close your web browser, clear the browser cache, and reopen your web browser.

## Troubleshooting Upgrade Failures

If attempts to upgrade software for your LifeSize system fail, follow these steps:

1. Ensure you have a valid upgrade image.
2. Reboot the system.
3. Attempt the upgrade again.
4. If a second attempt fails, note the error code returned.
5. If problems persist, contact your LifeSize Partner or LifeSize Technical Services.

## Upgrade Error Codes

Code	Problem	Description
1	Internal error	The system is missing critical files.
2	Switch to upgrade failed	The command to set the active partition failed.
3	Write failed	A write failure occurred while copying the image to the upgrade partition. This typically occurs when you use an upgrade image for another LifeSize product.
4	Read failed	Reading incoming data failed during the image upload. This typically occurs if the connection is broken during the upload.
5	Upgrade script failed	After the image successfully uploads, the system runs an upgrade script for final processing. This error indicates a failure in the script. This typically occurs when you use an upgrade image for another LifeSize product.
6	Unable to run upgrade script	The system was unable to run the upgrade script. This typically occurs when you use an upgrade image for another LifeSize product.
7	Unable to mount upgrade partition	After the image was copied to the system, the system failed to mount the image. This typically occurs if the upgrade image is corrupt or when you use an upgrade image for another LifeSize product.
8	No permission	The system failed to read the upgrade partition.
9	Corrupt image	The upgrade image is corrupt and unusable. This typically occurs because of a bad image or errors during upload to the device.
10	Bad argument	An invalid argument was submitted to the upgrade process. This typically occurs when you use an upgrade image for another LifeSize product.
11	Invalid signature	The encryption signature is invalid. This typically occurs if the image is corrupt or compromised.
12	Decrypt failed	The system was unable to decrypt the upgrade image. This typically occurs if the image is corrupt or compromised.
13	Developer system	The system is configured for development and can only be upgraded by a LifeSize representative.
14	Upgrade in progress	An upgrade is already in progress. The system supports only one upgrade at a time.
15	Upgrade license expired	A current license key for upgrading the system software does not exist on the device. Contact your LifeSize Partner to renew your maintenance agreement.



## Updating License Keys

System software upgrades from version 4.0.0 to a later release require a current license key to be installed on the system. An upgrade fails if a current license key does not exist. A current license key for upgrades is available when a maintenance agreement for the device is in effect. The **Upgrade License** field on the **System Information** page shows the expiration date of an upgrade license key installed on the system, if a key exists.

---

**NOTE** You can install a patch to a software release with an expired license key if the key was current when the software was released. The third digit of the three-digit version number identifies a patch; for example, 4.7.1 is patch 1 to release v4.7.0.

---

If a license key is not installed on a system during an upgrade or the installed key expired, the system attempts to check the license key status. Check for updates to license keys in the user interface or the web administration interface (if your LifeSize system has HTTP access through port 80). If your system does not have access, refer to [Installing a License Key Manually](#).

### Checking for License Key Updates

Check for license key updates from the user or the web administration interface.

1. From the user interface, navigate to **Administrator Preferences : System : License Keys**.  
-or-  
From the web administration interface, navigate to **Preferences : System : License Keys**.
2. Select **Update Keys**.
3. Press **OK**.

If the update is successful, **Success** appears in the **Update Key Status** box and the current license key and its expiration date appear in the **Upgrade License** box.

If an update to a license key fails in the user or web administration interfaces, one of the following messages appears in the **Update Key Status** box:

Status Message	Description
No Contract	A current maintenance agreement for the device does not exist. Contact your LifeSize Partner to renew your maintenance agreement. The renewal process may require 24 to 48 hours to complete.
Service Unavailable	The system failed to connect. The server may be down or your system may not have HTTP access. Contact LifeSize Technical Services if this condition persists and you have HTTP access, or install a key manually following the steps in <a href="#">Installing a License Key Manually</a> .
Invalid Key	A license key exists, but is invalid. Contact LifeSize Technical Services.

## Installing a License Key Manually

If you cannot obtain a license key using the license key update feature in the user or web administration interface, you can install a key manually from the web administration interface by doing the following:

1. From [lifesize.com/support](https://lifesize.com/support) click **Download Software**.
2. Enter the serial number of your LifeSize video communications system and click **Submit**.
3. Copy the license key from the software download page to your operating system clipboard.
4. Open a separate web browser window and access the web administration interface of your LifeSize system.
5. Navigate to **Preferences : System : License Keys**.
6. In the **Enter New Key** box, paste the license key that you copied in step 3.
7. Click **Add Key**.

---

**NOTE** **Add Key** is available only after you copy a key in the **Enter New Key** box.

---

The key and its expiration date appear in the **Upgrade License** box.

## Restoring Default Settings

Administrator preferences contain the system configuration settings. You may need to reset the system to its default state to correct problems or to return to a known configuration. Reset the system from the user interface or manually with the **Reset** button on the back of the codec.

### Resetting a System from the User Interface

1. From the **System Menu**, access **Administrator Preferences : System : System Reset**.
2. Enter the administrator password.

The system automatically reboots and the administrator password is reset to the default value (1 2 3 4). The user password also resets to a blank password. Users can then access **User Preferences** without a password. The system prompts you to complete the **Initial Configuration**.

---

**NOTE** If you reset the system using a remote access method, you must complete the reset from the user interface by navigating through the initial configuration screens and pressing **OK** when prompted to save the configuration.

---

## Resetting a System Using the Reset Button

Manually reset the system using the **Reset** button on the back of the codec. You can also reset the system to default settings using the alternate software image installed on the system. Typically, the alternate software image is the version that the system used before the last software upgrade.

---

**NOTE** You can use the reset button without removing power to the system.

---

Press and hold the reset button. The blue LED on the front of the codec changes color or behavior approximately every five seconds until the LED turns solid blue. The following table indicates the sequence of color and behavior changes of the LED and the corresponding system behavior when you release the reset button.

When the LED is This Color:	Release the Reset Button to Get This Result:
blue and red NOTE: The LED may remain in this state for more than 5 seconds. Depending on your viewing angle, the LED may appear purple.	The system reboots without changes to the configuration.
solid red	The system reboots without changes to the configuration.
flashing blue, longer duration on than off	The system reboots and resets preferences to default settings.
flashing blue, shorter duration on than off	The system reboots using the alternate software image installed on the system and resets preferences to default settings.
solid blue	The system reboots without changes to the configuration.

## Rebooting the System

The system reboots when you do any of the following:

Reboot the system.	<b>Administrator Preferences : Diagnostics : System Reboot</b> <b>User Preferences : Diagnostics : System Reboot</b>
Reset the system to its default state.	<b>Administrator Preferences : System : System Reset</b>
Restore a system configuration.	<i>Web administration interface:</i> <b>Preferences : System : System Reset : System Restore</b>
Enable or disable IPv6.	<b>Administrator Preferences : Network : General</b>
Change the <b>VLAN Tag</b> preference.	<b>Administrator Preferences : Network : General</b>
Change TCP reserved ports.	<b>Administrator Preferences : Network : Reserved Ports</b>
Change the UDP signaling port; enable or disable TCP or TLS signaling; or change the TCP or TLS signaling ports.	<b>Administrator Preferences : Communications : SIP</b>
Enable or disable <b>FIPS 140-2</b> .	<b>Administrator Preferences : Security : General</b>

Upgrade system software.	<i>Web administration interface:</i> <b>Maintenance : System Upgrade</b>
Initiate changes that result in fragmented memory and prevent the user interface from being successfully reloaded.	Repeatedly change the language that appears in the user interface or the display connected to a LifeSize system to a resolution that requires the user interface to be reloaded into memory; for example, from 720 to 1080.

If the user interface is not responding and you are unable to reboot the system, you can reboot the system by pressing the reset button on the back of the codec as described in [Restoring Default Settings](#). LifeSize recommends that you do not unplug power from the codec to reboot it.

## Saving and Restoring a System Configuration

**System Save** in the web administration interface creates a text file that contains command line interface commands to restore a saved configuration. The saved configuration includes preferences that can be set through the command line interface except the command line interface password and the password for the default SNMP user. Consider using **System Save** as part of regular system maintenance.

**System Restore** restores a system configuration using the saved configuration file. To customize a configuration, edit the file manually before restoring it. If you use a system configuration file for multiple systems, ensure that you edit unique settings, such as the system name or other credentials.

---

**NOTE** Configuration preferences and options vary across LifeSize system models and software releases. Restoring a system configuration using a file saved from a different model or software release may produce unexpected results. LifeSize recommends that you restore a configuration that was saved from the same system or the same system model and software release.

---

### Saving a System Configuration

1. In the web administration interface, navigate to **Preferences : System : System Reset**. If you wish to save system passwords in the file, select **Save passwords**. Passwords saved with this option are not encrypted.
2. Click **System Save**.
3. In the **Download file** dialog box, click **Yes**.
4. When prompted, choose a location in which to save the configuration file and then click **Save**.

## Restoring a System Configuration

---

**NOTE** Ensure that a saved configuration file exists before performing a restore.

---

1. If you chose not to save passwords when you saved the configuration file, passwords appear in the file as tokens surrounded by `###` characters and **FIX:** precedes the command in the configuration file; for example:

```
FIX: set admin password ###Password###
```

If you wish to replace these tokens with passwords before using the file to restore a system, delete **FIX:** and replace `###token###` with the password. If you do not edit these lines, error 09 (invalid command) appears in the command output when you restore the system; the **FIX:** lines are ignored; and values previously set for the passwords remain unchanged.

2. Hang up all calls connected to the system. If calls are connected when you perform a restore, a dialog box prompts you to continue or cancel the restore. If you continue, the system restore process terminates the calls.
3. In the web administration interface, navigate to **Preferences : System : System Reset**.
4. Click **System Restore**.
5. If an error dialog box appears, examine the errors. You may wish to copy and paste the errors into a text editing program for analysis and troubleshooting. Errors due to the presence of **FIX:** lines identify commands with token passwords that were not manually edited. Other errors may indicate a problem with restoring a specified preference or restoring the entire configuration.
6. Click **Continue**. The LifeSize system reboots and a dialog box indicates that the restore succeeded.

## Identifying the System

Change the system name, dialing numbers, and geographic location specified for the system in **Administrator Preferences : System : Identification**.

## Setting System Date and Time

Set the system time zone; or manually set the date and time in **Administrator Preferences : System : Date and Time**.

## Section 3: Preferences

This section lists configuration preferences as they are grouped in the interface. As you work with preferences, consider the following:

- Administrators have access to all of the preferences; users have access to a subset.
- Defaults for both users are the same.
- Changing a value in **Administrator Preferences** also changes the value in **User Preferences**. Likewise, changing a value in **User Preferences** changes the value in **Administrator Preferences**.

Access preferences as follows:

1. From the main screen, press  to access the **System Menu**.
2. Select **Administrator Preferences** (or **User Preferences**) and press **OK**.
3. If prompted, enter the password and press **OK**.  
By default, the administrator password is 1 2 3 4, and the user password is not set.

### Calls

Administrator Preferences : Calls User Preferences : Calls	Default Value	Available in User Preferences
Outgoing Call Bandwidth	Auto	
Incoming Call Bandwidth	Auto	
Outgoing Total Bandwidth	Auto	
Incoming Total Bandwidth	Auto	
Auto Bandwidth	Enabled	
Maximum Call Time	8 hours	
Maximum Redial Entries	10	X
Dominant Speaker Icon	Enabled	
Auto Answer	Disabled	X
Auto Answer Mute	Enabled	X
Auto Answer Multiway Call	Enabled	X
Admission Control	Enabled	

## Audio

Administrator Preferences : Audio User Preferences : Audio	Default Value	Available in User Preferences
Audio Codec Order: 1. AAC-LC 2. G.722.1C, licensed from Polycom® (48 kb/s) 3. G.722.1C, licensed from Polycom® (32 kb/s) 4. G.722.1C, licensed from Polycom® (24 kb/s) 5. G722.1, licensed from Polycom® (24 kb/s) 6. G.722 7. G.729 8. G.728 9. G.711 (μ-Law) 10. G.711 (A-Law)	N/A	
Active Microphone	Auto	
Active Microphone Volume	5	X
<i>LifeSize Express 220 Only:</i> Line In Volume	5	X
<i>LifeSize Room 220 and LifeSize Team 220 Only:</i> Line In 1 Volume	5	X
<i>LifeSize Room 220 and LifeSize Team 220 Only:</i> Line In 1 Association	Any Input	
<i>LifeSize Room 220 and LifeSize Team 220 Only:</i> Line In 2 Volume	5	X
<i>LifeSize Room 220 and LifeSize Team 220 Only:</i> Line In 2 Association	Any Input	
Primary Audio Output Test	Off	
Audio Mute	All Inputs	
Video Call Audio Output	HD Out	
Voice Call Audio Output	Phone	
Line Out Treble	0 dB	X
Line Out Bass	0 dB	X
Ring Tone Volume	5	X
DTMF Tone Volume	5	X
Status Tone Volume	5	X

## Telepresence

Administrator Preferences : Telepresence	Default Value	Available in User Preferences
Telepresence	Disabled	
Hide User Interface	Disabled	
HD Camera 1 Movement	Unlocked	
<i>LifeSize Room 220 and LifeSize Team 220 Only:</i> HD Camera 2 Movement	Unlocked	
<i>LifeSize Room 220 Only:</i> HD Camera 3 Movement	Unlocked	

## Video

Administrator Preferences : Video : Video Control	Default Value	Available in User Preferences
Far Control of Near Camera	Enabled	
Far Set of Camera Presets	Disabled	
Far Move to Camera Presets	Enabled	
Camera Presets Lock	Unlocked	
Camera Pan Direction	Perceived	
<i>LifeSize Room 220 and LifeSize Team 220 Only:</i> Digital Zoom	Disabled	
Default Primary Input	Auto	
Default Presentation Input	Auto	
Video Snapshots	Enabled	
<i>LifeSize Room 220 and LifeSize Team 220 Only:</i> HD Camera 1 Name	HD Camera 1	
<i>LifeSize Room 220 Only:</i> Auxiliary Video Input Name	DVD	
HD Input 1 Name	HD 1	
HD Input 1 Type	Auto	
<i>LifeSize Room 220 Only:</i> HD Input 2 Name	HD 2	
<i>LifeSize Room 220 Only:</i> HD Input 2 Type	Auto	
DVI-I Input Name	PC	
DVI-I Input Type	Auto	
Stretch Video	Disabled	



Administrator Preferences : Video : Video Quality	Default Value	Available in User Preferences
Video Bandwidth Balance	90%/10%	
Primary Video Motion	10	
Presentation Video Sharpness	10	
Video Encoder Quality	-2	
Video MTU	1440 bytes	
Adaptive Motion Control	Enabled	

Administrator Preferences : Video : Record and Stream	Default Value	Available in User Preferences
Recorder	Disabled	
Recorder Hostname	No default	
Recorder Port	443	
Recording Key	No default	
Auto Record	Disabled	
Default Recording Layout	All Callers	

## Security

Administrator Preferences : Security : General	Default Value	Available in User Preferences
FIPS 140-2	Disabled	
HTTP	Enabled	
SSH	Enabled	
Telnet	Disabled	
SNMP	Enabled	
H.235 AES Security	Disabled	

Administrator Preferences : Security : Passwords	Default Value	Available in User Preferences
Administrator Password	1234	
User Password	not set	

## Network

Administrator Preferences : Network : General	Default Value	Available in User Preferences
DHCP	Enabled	
IP Address	No default	
Subnet Mask	255.255.255.0	
Default Gateway	No default	
Hostname	LifeSize	
DNS Servers	No default	
Name Search Domains	No default	
Network Speed	Auto	
VLAN Tag	No default	
NTP Server Hostname	No default	
802.1x Authentication	Disabled	
IPv6	Disabled	
IPv6 Configuration	Auto	
IPv6 Address	No default	
IPv6 Router	No default	

Administrator Preferences : Network : NAT	Default Value	Available in User Preferences
Static NAT	Disabled	
NAT Public IP Address	No default	

Administrator Preferences : Network : Reserved Ports	Default Value	Available in User Preferences
UDP Lowest Value	60000	
UDP Highest Value	64999	
TCP Lowest Value	60000	
TCP Highest Value	64999	

Administrator Preferences : Network : Network QoS	Default Value	Available in User Preferences
Network QoS	None	
DiffServ Audio Priority	46	
DiffServ Video Priority	34	
DiffServ Data Priority	46	
IntServ Audio Priority	5	
IntServ Video Priority	4	
IntServ Data Priority	5	
IntServ ToS	None	

Administrator Preferences : Network : LifeSize Transit	Default Value	Available in User Preferences
LifeSize Transit	Disabled	
Transit Hostname	No default	
Transit Username	No default	
Transit Password	No default	
Transit ICE	Enabled	
Transit Signaling	TCP Only	
Web Proxy URL	No default	
Web Proxy Username	No default	
Web Proxy Password	No default	

## Communications

Administrator Preferences : Communications : General	Default Value	Available in User Preferences
Multiway Calls	Enabled	
Video Dialing	Auto	
Voice Dialing	VoIP	
<i>LifeSize Room 220 and LifeSize Team 220 Only.</i> PSTN	Enabled	
Presentations	Enabled	
Auto Start Presentation	Auto	
LifeSize Networker IP Address	No default	

Administrator Preferences : Communications : H.323	Default Value	Available in User Preferences
H.323	Enabled	
H.323 Name	Conference Room plus last 2 bytes of the MAC address	
H.323 Extension	last 2 bytes of the MAC address	
Gatekeeper ID	No default	
Gatekeeper Mode	Disabled	
Gatekeeper IP Address 1	No default	
Gatekeeper Port 1	1719	
H.460	Disabled	
H.323 Tunneling	Disabled	
Gatekeeper IP Address 2	No default	
Gatekeeper Port 2	No default	
Gatekeeper Authentication	Disabled	
Gatekeeper Username	No default	
Gatekeeper Password	No default	

Administrator Preferences : Communications : SIP	Default Value	Available in User Preferences
SIP	Enabled	
SIP Username	LifeSize	
Authorization Name	No default	
Authorization Password	No default	
SIP Server Type	Auto	
SIP Registration	Through Proxy	
SIP Proxy	Disabled	
Proxy Hostname	No default	
SIP Registrar	Disabled	
Registrar Hostname	No default	
Internal Server	No default	
External Server	No default	
SIP Signaling	Auto	
UDP Signaling Port	5060	
TCP Signaling Port	5060	
TLS Signaling Port	5061	

## System

Administrator Preferences : System : General	Default Value	Available in User Preferences
Auto Reboot	No	

Administrator Preferences : System : Identification	Default Value	Available in User Preferences
System Name	Conference Room	
Video Number	No default	
Voice Number	No default	
Location	United States	

Administrator Preferences : System : Date and Time	Default Value	Available in User Preferences
Time Zone	GMT (Greenwich Mean Time)	
Day, Month, Year, Hour, Minutes, Seconds	GMT values	

Administrator Preferences : System : Serial Ports	Default Value	Available in User Preferences
<i>LifeSize Room 220 Only:</i> RS-232 Port 1 Shell	None	
<i>LifeSize Room 220 Only:</i> RS-232 Port 1 VISCA Input	None	
<i>LifeSize Room 220 Only:</i> RS-232 Port 1 Baud Rate	38400	
<i>LifeSize Room 220 Only:</i> RS-232 Port 1 Erase Character	Backspace (Ctrl-H, ASCII 10)	
<i>LifeSize Room 220 Only:</i> RS-232 Port 1 Flow Control	None	
USB Serial Shell	None	
USB Serial VISCA Input	None	
USB Serial Baud Rate	38400	
USB Serial Erase Character	Backspace (Ctrl-H, ASCII 10)	
USB Serial Flow Control	None	

Administrator Preferences : System : License Keys	Default Value	Available in User Preferences
Update Keys	Not configurable; checks for updates to license keys	

Administrator Preferences : System : System Reset	Default Value	Available in User Preferences
System Reset	Prompt for administrator password	

## Recent

Administrator Preferences : Recent	Default Value	Available in User Preferences
Fields reflect recent changes	No default	

## Directory

Administrator Preferences : Directory : General	Default Value	Available in User Preferences
Local Directory	Enabled	
Corporate Directory	Enabled	
Meetings Directory	Enabled	

Administrator Preferences : Directory : Auto Discovery	Default Value	Available in User Preferences
Auto Discovery	Enabled	
Auto Discovery Subnets	No default; discovers local subnet only if left blank	
Auto Discovery Ignored Subnets	No default	

Administrator Preferences : Directory : LDAP	Default Value	Available in User Preferences
LDAP	Disabled	
LDAP Hostname	No default	
LDAP Username	No default	
LDAP Password	No default	
LDAP Base	No default	
LDAP Filter	No default	
LDAP Refresh	Never	

## Appearance

Administrator Preferences : Appearance : General User Preferences : Appearance	Default Value	Available in User Preferences
Language	English (US)	X
Fade Out Timeout	10 seconds	X
Caller ID Timeout	1 minute	X
Company Logo	Default	
LCD Contrast	6	X
Screen Saver	Logo	X
Screen Saver Timeout	10 minutes	X
Sleep Timeout	10 minutes	X
Hide IP Addresses	Disabled	
Clear Last Number Dialed	Disabled	

Administrator Preferences : Appearance : Backgrounds User Preferences : Backgrounds	Default Value	Available in User Preferences
Display 1 Background Image	Default	X
Display 1 Background Color	Sky Blue	X
<i>LifeSize Room 220 and LifeSize Team 220 Only.</i> Display 2 Background Image	Default	X
<i>LifeSize Room 220 and LifeSize Team 220 Only.</i> Display 2 Background Color	Sky Blue	X

Administrator Preferences : Appearance : Layout User Preferences : Appearance	Default Value	Available in User Preferences
Picture In Picture	Auto	X
Display 2 Layout	None	
<i>LifeSize Room 220 Only.</i> Multiway Call Layout	All Callers	



Administrator Preferences : Appearance : Displays	Default Value	Available in User Preferences
Display 1	No default; information field	
Display 1 Resolution	Auto	
Display 1 Energy Saver	Disabled	
Display 2	No default; information field	
<i>LifeSize Room 220 and LifeSize Team 220 Only:</i> Display 2 Resolution	Auto	
Display 2 Energy Saver	Disabled	

## Diagnostics

Administrator Preferences : Diagnostics : High Definition Camera 1 User Preferences : Diagnostics : High Definition Camera 1	Default Value	Available in User Preferences
HD Camera 1 Auto Exposure	Full Frame	X
HD Camera 1 Brightness	0	X
HD Camera 1 White Balance	Auto	X
Camera Anti-Flicker	Auto	X
HD Camera 1 Color Temperature	0	X

Administrator Preferences : Diagnostics : High Definition Camera 2 User Preferences : Diagnostics : High Definition Camera 2	Default Value	Available in User Preferences
<i>LifeSize Room 220 and LifeSize Team 220 Only</i>		
HD Camera 2 Auto Exposure	Full Frame	X
HD Camera 2 Brightness	0	X
HD Camera 2 White Balance	Auto	X
Camera Anti-Flicker	Auto	X
HD Camera 2 Color Temperature	0	X

Administrator Preferences : Diagnostics : High Definition Camera 3 User Preferences : Diagnostics : High Definition Camera 3	Default Value	Available in User Preferences
<i>LifeSize Room 220 Only</i>		
HD Camera 3 Auto Exposure	Full Frame	X
HD Camera 3 Brightness	0	X
HD Camera 3 White Balance	Auto	X
Camera Anti-Flicker	Auto	X
HD Camera 3 Color Temperature	0	X

Administrator Preferences : Diagnostics : DVI-I Input User Preferences : Diagnostics : DVI-I Input	Default Value	Available in User Preferences
DVI-I Input Horizontal Position	50	X
DVI-I Input Vertical Position	50	X
DVI-I Input Coarse Tuning	50	X
DVI-I Input Fine Tuning	50	X
DVI-I Input Brightness	50	X
DVI-I Input Contrast	50	X
DVI-I Input Scaling	20%	X

Administrator Preferences : Diagnostics : Color Bars	Default Value	Available in User Preferences
Color Bars	Not configurable; used to calibrate display	

Administrator Preferences : Diagnostics : Call Counters	Value	Available in User Preferences
Since System Reset: Total Calls Connected Video Calls Connected Voice Calls Connected Last Call Time Total Call Time Longest Call Time	No default; information fields	
Since System Reboot: Total Calls Connected Video Calls Connected Voice Calls Connected Total Call Time Longest Call Time	No default; information fields	

Administrator Preferences : Diagnostics : Network Utilities	Default Value	Available in User Preferences
Command	Ping	
IP Address	No default	
Start/Stop	Start	

Administrator Preferences : Diagnostics : System Reboot	Default Value	Available in User Preferences
Dialog Prompt	Yes/(No)	X

## Section 4: Troubleshooting

The following sections describe symptoms, possible causes, and potential solutions for common problems you may encounter with your LifeSize system.







When experiencing a problem, visually inspect the unit. Ensure that the system has not been exposed to water or heat sources or was physically damaged.

Improperly connected or loose cables are common problems with hardware units. When investigating a system problem, first inspect the external controls and cable connections. Ensure that connections are correct and secure and that nothing is obstructing the cables. Contact your administrator for information about proper cabling.

For online troubleshooting topics, search the LifeSize Knowledge Base. From [lifesize.com/support](https://lifesize.com/support), click **Knowledge Base**.

### Initialization

As your system initializes, one or more of the following icons may appear in the user interface:

Icon	Condition
	Indicates that the communication subsystem is initializing. If this icon reappears after the system has booted, a problem has occurred. Reboot the system.
	Indicates that the system is initializing, functionality on the main screen is disabled, and no entries appear in the REDIAL list. This icon also appears when a new device is connected to the system after the system boots and disappears when the device is ready. If this icon persists, a problem has occurred and rebooting the system is necessary.
	Indicates that LifeSize Networker connected to the codec is initializing. Most of the main screen elements are not visible. If LifeSize Networker never fully initializes, this icon persists until LifeSize Networker or the system is rebooted. Contact your administrator.
	Indicates that LifeSize Networker connected to the codec has initialized and is attempting to connect to the ISDN network. If this icon persists, contact your administrator.
	Indicates that the phone connected to the system is booting.
	Indicates that the system is enabling FIPS security.

## Adjusting Room Lighting

Ensure that the system maintains the best possible image quality by altering the lighting and background colors of your environment. If light levels are too low, you may consider adding artificial lighting. Indirect light from shaded sources or reflected light from pale walls often produces excellent results.

Avoid the following:

- Direct sunlight on the subject matter, the background, or the camera lens, which creates harsh contrasts
- Direct illumination of the subject matter and camera lens
- Colored lighting
- Harsh side lighting or strong light from above

Improve dim scenes by [Adjusting Camera Brightness](#).

## Camera Issues

If you are unable to pan, tilt, or zoom a camera that has these capabilities, ensure that the remote control contains three AAA batteries that are in good working condition. Verify that no objects are obstructing the sensor on the front of the camera and that the LED on the front of the camera flashes bright blue when you use the remote control to perform a task.

If the camera does not display video, ensure that the camera is connected to the LifeSize system with a camera cable to the appropriate camera input or contact your administrator. Also ensure that the primary input is set to the high definition camera as described in [Changing Video Inputs](#).

Verify that the blue LED on the front of the camera is lit, which indicates that power is active, and reboot the system if necessary to verify that the camera turns on. To reboot the system, access **User Preferences : Diagnostics : System Reboot**. If a system reboot does not resolve the problem and LifeSize Camera 200 is connected to the system, you may need to reapply power to LifeSize Camera 200. Contact your administrator for assistance. Read more at [Using Camera Diagnostic Preferences](#).

## DVI-I Input Issues

Adjust the horizontal and vertical positioning, brightness, and contrast of DVI-I input from a device connected to the DVI-I input  on the LifeSize codec. Typically, this input device is a laptop or personal computer that is used to send data during a presentation. You can also perform coarse or fine tuning of the clock frequency and adjust the percentage of scaling so the image best fits your display. To adjust DVI-I input settings, access **User Preferences : Diagnostics : DVI-I Input**.

## Packet Loss

Packet loss can result in noticeable video or audio performance issues and can be caused by signal degradation over the network medium, oversaturated network links, corrupted packets rejected in-transit, faulty networking hardware, and misconfigured system drivers or network applications. Refer to the technical note *Troubleshooting Packet Loss* for steps you may take to address packet loss.

## Display Issues

The following issues are related to the user interface or the display.

### Display Failures

If data does not appear on the display, ensure cables are properly connected on the display and that the display cable is connected to the HD 1 output on the back panel of the codec. Also ensure that you have selected the correct input. Refer to [Changing Video Inputs](#).

If the video image and user interface appear washed out or too bright, examine your HDTV input settings to make sure the HDTV has the appropriate resolution. Some HDTVs, particularly plasma displays, allow you to configure the native resolution of the input device from the HDTV administration interface.

### Poor Quality Display

If you have poor quality or unreadable data on the phone display, adjust the **User Preferences : Appearance : LCD Contrast** setting. LifeSize recommends using the default setting (6).

If the colors on the display appear incorrect, verify that the display cable is properly connected to the display.

### Missing Input

If you did not connect all possible video inputs, the input selection dialog shows a black image by default. Connect the necessary input or choose a different input as described in [Changing Video Inputs](#).

### Poor Quality Far End Video



During a call, the LifeSize system automatically selects the best video algorithm for the video source and capabilities of the remote system. If you experience poor motion handling or visible tiling in the far end picture during a video call, contact your administrator.

## Audio Issues

A LifeSize system automatically selects the best audio algorithm for the call rate and the remote system's capabilities. The following issues are related to the audio quality.

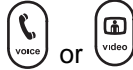
### Absent Dial Tone



If you do not receive a dial tone after pressing  or  on the LifeSize phone to initiate a call, ensure the line out is securely connected. An absent dial tone may also result from an unavailable analog phone line connection. If you are connecting with PSTN, ensure the analog phone connection is secure and that it is connected to an active phone line jack.

### Problematic Sound Quality

If the far side is hearing an echo or distortion, the microphone connected to your LifeSize system may be too close to the speakers. Repositioning the microphone may solve this problem.

The LEDs on the LifeSize phone flash blue to indicate an incoming call. If you are unable to hear the phone ring when an incoming call arrives, adjust the volume using the up and down volume key. If you still experience audio problems, adjust **Ring Tone Volume** in **User Preferences : Audio**.



Muffled audio reception from the far side may be caused by highly reverberant rooms. If you are experiencing poor audio reception, add more sound absorbency to the room and speak in close proximity to the phone or microphone.

Degradation in the audio quality can also be caused by faulty microphones or dust and debris on the microphones. Do not use any kind of liquid or aerosol cleaner on LifeSize devices that include microphones. A soft, slightly damp cloth should be sufficient to clean the top surface of the units.

### Distorted Audio

Ensure that speakers are not obscured or damaged at either end of the call. Do not stack items on top of the phone. Ensure both ends are not muted. Verify that the audio out cables are properly connected to the display and that external speaker systems are powered and configured correctly. If an external speaker system has its own volume control, adjust the volume on the LifeSize audio output to near maximum (in the range from 7-10) and adjust the volume control on the external speaker system for the best results.

## Power and Connectivity Issues

If a call does not successfully connect, verify that you dialed a working number and that the far end is powered on and available. Verify that the network is ready and available. Network status is indicated at all times in the status bar. If the LifeSize system is connected to the local network, a green  network status icon appears. A yellow  (in progress) or red  (disconnected) network status icon indicates a problem with the network connection. You may need to reboot a system that is not responding to commands from the remote control.

## Using the Remote Control in the Web Administration Interface

From the web administration interface, press **Remote Control** to display an image that allows you to control your system in the same way as the physical remote control. As you use the web remote control, consider the following:

- Clicking the LifeSize logo on the image switches the image and functionality from a black to a silver remote control (or from silver to black). Click the logo again to switch back.
- The web administration interface synchronizes with the physical remote control used and with commands issued from the command line. If a control system uses a command that emulates the silver remote control, the web administration interface shows the silver remote.

## Using Diagnostics Preferences and Tools

Diagnostic preferences and tools that are available to all users include high-definition camera preferences, input preferences for devices connected to the codec, and a system reboot option. Administrators can access these preferences and tools through **User Preferences** or **Administrator Preferences : Diagnostics**. Read more at [Preferences](#).

---

**NOTE** *Web administration interface:* To view the effect of changes made to camera diagnostic preferences on the **Diagnostics : Cameras** page, click **Save Changes** and then **Refresh**.

---

Diagnostic preferences and tools available only to administrators in **Administrator Preferences : Diagnostics** include call counter statistics, color bar settings, and network utilities.

## Using Network Utilities

Troubleshoot network connection issues with your system using the ping and traceroute utilities in **Administrator Preferences : Diagnostics: Network Utilities**. The **ping** command tests responsiveness between two devices. The **traceroute** command tests responsiveness and traces the path of a packet from one device to the other.

## Using Camera Diagnostic Preferences

Use the camera diagnostic preferences in **Administrator Preferences** or **User Preferences : Diagnostics** to adjust camera brightness and white balance and correct some types of flicker that may appear in the video. You can also adjust or disable auto exposure to control image brightness. Diagnostic camera preferences for auto exposure, camera brightness, and white balance are available only if the selected camera is connected to the codec and **Ready** appears as the status for the camera on the **System Information** page.



## Adjusting Camera Auto Exposure

Auto exposure refers to how a camera automatically adjusts its aperture and shutter speed to affect video image brightness. If your LifeSize system is connected to any LifeSize PTZ camera through firewire or HDMI, choose an auto exposure method for the camera by specifying one of the following values for **HD Camera Auto Exposure** in **User Preferences : Diagnostics : High Definition Camera**:

Full Frame	Default value. Adjusts exposure for the average brightness of a full frame of video.
Center-weighted	Adjusts exposure for the average brightness of a full frame of video, but assigns a higher weight to the center of the frame.
Spot	Adjusts exposure for the average brightness of a small area in the center of the frame.
Manual	Disables auto exposure.

Affect auto exposure or adjust exposure manually when auto exposure is disabled by adjusting **HD Camera Brightness**.

## Adjusting Camera Brightness

Camera brightness refers to the amount of light received through the lens of the camera. Improve dim scenes by adjusting room lighting and manually adjusting the camera brightness. To adjust camera brightness, set **HD Camera Brightness** in **User Preferences : Diagnostics : High Definition Camera**.

## Adjusting Camera White Balance

Camera white balance refers to how a camera references the color white, which is a mixture of all colors. Adjust the white balance when video color appears to be unbalanced. White balance is affected by the type of light source. To adjust the camera white balance, set **HD Camera White Balance** in **User Preferences : Diagnostics : High Definition Camera**.

By default, your LifeSize system determines the proper value for the camera's white balance by testing the initial lighting mix in the room. The video system does not continuously or periodically retest the room lighting to adjust the white balance. If you change the lighting during a call, allow the video system to adjust to the new lighting as follows:

1. Navigate to **Administrator Preferences : Diagnostics : High Definition Camera 1 : HD Camera 1 White Balance** and select a value other than *Auto*.
2. Return the setting to *Auto*.

## Adjusting Camera Anti-Flicker

Lights powered by a 50 Hz power source can produce a flicker that the camera captures and transmits to the system. If you are using lights powered by a 50 Hz power source and observe a flicker in the video, select the *50 Hz* option in **User Preferences : Diagnostics : High Definition Camera : Camera Anti-Flicker**. The default option is *Auto*.

---

**NOTE** The option chosen for this preference applies to all cameras connected to the system.

---

Some camera exposure settings designed for use in rooms lit by sunlight may result in a flicker. To remove the flicker, increase the **HD Camera Brightness** setting in **User Preferences : Diagnostics : High Definition Camera**.

## Adjusting Camera Color Temperature

With **Camera White Balance** set to a value other than *Auto*, adjust **Color Temperature** to favor red or blue. Adjust the slider to the left to favor red and to the right to favor blue.

## Downloading Call History

Download call history as a comma separated value (CSV) file from the **Diagnostics** page in the web administration interface. Click **Call History** and then click **Download Call History**. When prompted, choose a location to save the file. Downloading call history from the web administration interface retrieves a maximum of 26 records.

## Copying Screen Text to the Clipboard

The web administration interface supports copying data from most pages to the operating system clipboard. This feature facilitates troubleshooting by enabling you to paste configuration information into an email or text editor. If a page supports this feature, a **Copy** button appears in the lower right corner of the screen. Click **Copy** to copy the data on the screen to the clipboard.

## **February 2011**

### **Copyright Notice**

©2005 – 2011 Logitech, and its licensors. All rights reserved.

LifeSize Communications, a division of Logitech, has made every effort to ensure that the information contained in this document is accurate and reliable, but assumes no responsibility for errors or omissions. Information in this document is subject to change without notice. Companies, names, and data used in examples herein are fictitious unless noted. This document contains copyrighted and proprietary information which is protected by United States copyright laws and international treaty provisions. No part of the document may be reproduced or transmitted, in any form or by any means, electronic or mechanical, for any purpose, without the express written permission from LifeSize Communications.

### **Trademark Acknowledgments**

LifeSize, the LifeSize logo and other LifeSize marks, are registered trademarks or trademarks of Logitech. All other trademarks are the property of their respective owners.

### **Patent Notice**

For patents covering LifeSize® products, refer to [lifesize.com/support/legal](http://lifesize.com/support/legal).

### **Contacting Technical Services**

LifeSize Communications welcomes your comments regarding our products and services. If you have feedback about this or any LifeSize product, please send it to [feedback@lifesize.com](mailto:feedback@lifesize.com). Refer to [lifesize.com/support](http://lifesize.com/support) for additional ways to contact LifeSize Technical Services.